

SECUTEST[®] SII

Test Instrument for DIN VDE 0701, 0702 and 0751

3-349-223-03
8/11.05

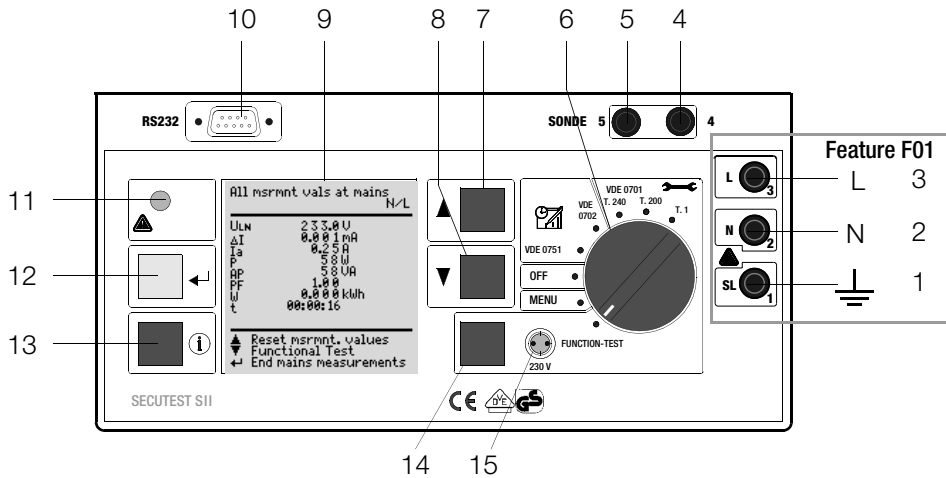



Note

Contact problems with exposed conductive parts when using the standard probe with test tip





In order to assure good contact, surface coatings must be removed from devices under test with special tools at a suitable location so that the surface has a metallic shine.

The tip of the test probe is not suitable for scratching away paint, because this may impair its coating and/or mechanical strength.

The brush probe may be more suitable than the test probe in certain individual cases.

These operating instructions describe an instrument with firmware version 6xx.

Upper left figure

- 1 Jack for protective conductor at device under test (feature F01)
- 2 Jack for neutral conductor at device under test (feature F01)
- 3 Jack for phase conductor at device under test (feature F01)
- 4 Jack for connecting the probe
- 5 Jack for connecting the probe
- 6 Function selector switch
 - VDE-...: Automatic test sequence according to selected standard
 - OFF: Instrument is switched off (no disconnection from mains)
 - MENU: Setup: Device configuration
R_{SL}...: Individual tests
 - FUNCTION TEST: Function test
- 7  scroll key for menu and parameter selection
- 8  scroll key for menu and parameter selection
- 9 LCD panel
- 10 Socket connector for RS 232 interface
- 11 Signal lamp for mains connection error
- 12  key for entry, for starting test sequences and for finger contact
- 13  help key (context sensitive)
- 14 Key next to the  symbol for switching test voltage to the test socket (only possible if symbol LED is blinking)
- 15 Signal lamp for the functions text

Lower Left figure

- 16 Push-buttons (left and right) for releasing the handle from its snap-in position
- 17 Standard outlet socket (test socket) for connecting the device under test
- 18 Push-buttons (left and right) for releasing the lid
- 19 Compartment for probe and accessories
- 20 Lid
- 21 Test probe
- 22 Carrying handle and tilt stand
- 23 Cover or printer module (feature E01)

Overview of Available Probe Types

Probe Type	Application	Special Features
Standard probe (test probe with coil-cable and alligator clip)	Text current: 200 mA	none
SK2 ¹⁾	Test current: 200 mA	Probe with plain cable (not coil-cable), 2 meters long
SK5 option (feature KD01 or accessory)		Special probe in combination with "automatic recognition of measuring point change" function (see chapter 13).
Brush probe ¹⁾ Can be plugged onto all above listed probes and test probes	Leakage current, protective conduc- tor resistance	For contacting devices under test with rotating, vibrating, exposed conductive parts

¹⁾ Accessory



Note

Use of probes other than those specified above:

Cables plugged into jacks 4 and 5 must be short-circuited in order to perform the probe test, either by plugging the cable ends together or by means of a conductive surface at the device under test (4-wire measurement).

Remove any corrosion from the device under test.



Data Security

Measurement data, report data and user entries are stored to RAM at the SECUTEST®PSI printer module (feature E01), as long as the respective battery supplies the required amount of voltage.

Save your data to a PC on a regular basis in order to prevent any loss of data at the printer module.

We assume no liability for data loss.

We recommend the following PC programs for data processing and data management:

- **PS3** (transmission of measurement data to a PC, documentation, management, report generating and deadline follow-up)
- **SECU 601** (program for activating the data base function in the instrument (DBmed option), if not already available as a feature)
- **PC.doc-WORD** (report and list generation)
- **PC.doc-ACCESS** (test data management)

Contents	Page	Contents	Page
1 Applications	6	9 Individual Measurements	16
1.1 Table: Types of DUTs – Tests – Regulations	6	9.1 Measuring Protective Conductor Resistance	16
1.2 Table: Individual Measurements and Regulations	6	9.2 Insulation Resistance R_{ISO}	17
1.3 Table: Leakage Current Types	7	9.3 Measuring Leakage Current	19
1.4 List of Possible Options for SECUTEST®SII Device Series	7	9.3.1 Contact Current $I_{Contact}$ (probe current, housing leakage current)	19
2 Safety Features and Precautions	8	9.3.2 Residual Current ΔI	19
3 Initial Start-Up	9	9.3.3 Device Leakage Current I_{DL} per DIN VDE 0751	19
3.1 Connection to the Mains (230 V, 50 Hz)	9	9.4 Equivalent Leakage Current	20
3.2 Automatic Recognition of Mains Connection Errors	10	9.5 Probe Voltage U_{probe} – Max. 300 V	21
4 General Notes	10	9.6 Alternating / Direct Voltage $U_{AC/DC}$ – Max. 253 V (feature F01)	22
4.1 Online Instructions	10	9.7 Resistance R (feature F01)	22
4.1.1 Automatic Safety Class Selection	10	9.8 Measurements with Accessories (feature F01)	22
4.1.2 Manual or Automatic Operating Sequences	10	9.8.1 Alternating Current I_Z with Clip-On Transformer (feature F01)	22
4.2 Online Help	10	9.8.2 Temperature T with Pt100/1000 Sensor (feature F01)	23
4.3 Adjusting Contrast	11	10 Function Test	24
4.4 Configuring Device Parameters, Setting Date and Time	11	11 Measurements – Selector Switch Settings for Standards	26
4.5 Configuring Measurement and Sequence Parameters	11	11.1 Test Sequences	26
4.6 Setting Limit Values	11	11.2 Setting Up Test Sequences	27
4.7 Saving the Settings	11	11.3 Configuring Measuring Parameters	27
5 Classification of Devices Under Test	12	11.4 Testing Devices in Accordance with DIN VDE 0701, Parts 1 and 200	28
5.1 Safety Classes	12	11.5 Testing Devices in Accordance with DIN VDE 0701, Part 240	30
5.2 Application Parts (electrical medical devices)	12	11.6 Testing Devices in Accordance with DIN VDE 0702:2004	32
6 Abbreviations	13	11.7 Testing Extension Cables for VDE 0701, Part 1, and VDE 0702 (option: EL1 adapter)	34
7 Connecting the Device Under Test	14	11.8 Testing Multiple Outlets for VDE 0702 (optional EL1 adapter)	35
8 Configuring Device Parameters	15	11.9 Testing in Accordance with DIN VDE 0751	36

Contents	Page	Contents	Page
12 Storage in PSI Module (Feature E01) and Database Operations (Feature KB01 or DBmed option)	38	19 Maintenance - Calibration	46
12.1 Storing Measurement Data in the PSI Module	38	20 Repair and Replacement Parts Service DKD Calibration Laboratory and Rental Instrument Service	46
12.2 Database Operations	38	21 Product Support	47
12.2.1 Setting Up Test Sequences with PC Software	38		
12.2.2 Storing Test Results to the SECUTEST-SII	38		
13 Remote Control (Feature KD01 or SK5 Option)	38		
14 Printing via PSI Module (Feature E01) or with the Printer Adapter (DA-II accessory)	39		
14.1 Print Out Test Data at the PSI Module	39		
14.2 Printing Test Results in Report Form	39		
15 Direct Print-Out (feature KE01, SECU-dd option)	39		
16 Characteristic Values	40		
17 RS 232 Interface	43		
17.1 Transmission of Measurement Results to the SECUTEST®PSI	43		
17.2 PC Connection	43		
17.2.1 Software Evaluation of Measurement Results	43		
17.2.2 Instrument Control via Interface Commands	43		
17.3 Interface Configuration and Protocol	43		
18 Appendix	44		
18.1 Evaluation of Measured Values for Individual Measurements as well as for Calculated Quantities	44		
18.2 Index	45		

Condensed instructions for PS3 software for maintenance and equipment management are provided with the PS3 CD ROM.

They include important instructions regarding the following topics:

- PS3 demo with additional instructions
- Special features for reading measured values in from a data file

1 Applications

1.1 Table: Types of DUTs – Tests – Regulations

	Start-up and Modifications	Testing after Repairs			Periodic Testing	
		DIN VDE 0701 Part 1:2000	DIN VDE 0701 Part 240	DIN VDE 0751:2001	DIN VDE 0702:2004	DIN VDE 0751:2001
Devices under test to be tested in accordance with the following regulations	DIN VDE 0751:2001					
Laboratory instruments		•			•	
Measuring and control instruments		•			•	
Voltage generation devices		•			•	
Electric tools		•			•	
Electric heating devices		•			•	
Electric motor devices		•			•	
Lamps		•			•	
Devices for entertainment electronics, information and communications technology		•			•	
Cable reels, extension and connection leads		•			•	
Data processing and office equipment			•		•	
Electrical medical devices, application parts	•		•		•	



Attention!

The test instrument may not be used for measurements within electrical systems!

1.2 Table: Individual Measurements and Regulations

Individual Measurements per Regulation	Test current [A]	DIN VDE 0701, part 1	DIN VDE 0701, part 200	DIN VDE 0701, part 240	DIN VDE 0702	DIN VDE 0751
		Protective conductor resistance	0.2	•	•	•
Insulation resistance		•	•		•	
Equivalent leakage current		•	•	•	•	
Equivalent (device) leakage current						•
Residual current		•			•	•
Contact current		•			•	
Absence of voltage (exposed conductive parts)				•		
Patient leakage current						•
Device leakage current						•

Key

- Required test

1.3 Table: Leakage Current Types

DIN VDE 0701-1	DIN VDE 0702-1	DIN VDE 0751-1 (2001)	The following is measured:
Equivalent leakage current	Equivalent leakage current		PROBE (connected to protective conductor) to L & N
		Equivalent device leakage current	PROBE (open protective conductor) to L & N
Contact current / measurement for absence of voltage	Contact current / measurement for absence of voltage		Probe to PE
			Protective conductor to PE
		Device leakage current during operation	Protective conductor interrupted, probe to PE
Protective conductor current with differential current measurement	Protective conductor current with differential current measurement	Device leakage current during operation, differential current method	See chapter 9.3.2

Key

NC = Normal conditions

PAT = Patient application part

PE = Potential earthing \triangleq , mains protective conductor

DPE = Protective conductor of the device under test

1.4 List of Possible Options for SECUTEST®SII Device Series

Example for complete type designation (article number) of a SECUTEST®SII:

M7030 E01 KD01 KE01 (only the designation of the basic device, M7030, and features other than 00 are specified)

Features		00	01	02	03	04	05	06	07	08	09	10	11	99
Design	A	GM												
Mains Connection for Respective Country	B	D			F						CH		2)	
User Interface Language	C	D	GB											
Configuration (settings in the setup menu)	D	GM							3)					
Printer Module SECUTEST®PSI	E	w/o	with											
Additional Test Sockets (cannot be retrofitted)	F	w/o	with 4)											
Database DBmed Option (Z853H)	KB	w/o	with											
Remote Control SK5 Special Cable (Z745K)	KD	w/o	with											
Direct Printing After Each Measurement for Automatic Test Sequences 1)	KE	w/o	with											
Read-Out via RS 232, SECU-dd Option (Z853L)														
DKD calibration certificate	L	w/o	with											

1) Each measured value is documented in this case, as opposed to the results of a test sequence for which the poorest value for each given test is displayed.

2) Adapter set for international use (feature B00 - earthing contact socket - included)

3) With configuration for hospital beds of Safety Class 2 (pre-adjusted)

4) For multimeter functions, for measurements with accessories and for devices under test without plug, including 3 plug-on quick clips

2 Safety Features and Precautions

The SECUTEST[®]SII test instrument has been manufactured and tested in accordance with the following safety regulations:

IEC 61010-1 / DIN EN 61010-1 / VDE 0411-1 and DIN VDE 0404, DIN VDE 0413 Part 2 and 4.

When used for its intended purpose, the safety of the user, the test instrument and the device under test (electrical equipment or electrical medical device) is assured.

Read the operating instructions carefully and completely before placing your test instrument into service. Follow all instructions contained therein. Make sure that the operating instructions are available to all users of the instrument.

Tests may only be performed by a qualified electrician or under the supervision and direction of a qualified electrician. The user must be instructed by a qualified electrician in the execution and evaluation of tests.



Note

Manufacturers and importers of electrical medical devices must provide documentation for the performance of maintenance by trained personnel.

Observe the following safety precautions:

- The instrument may only be connected to electrical systems with a maximum of 230 V which are protected with a fuse or circuit breaker with a maximum rating of 16 A.
- Measurements within electrical systems are prohibited.
- Be prepared for the occurrence of unexpected voltages at devices under test (for example, capacitors can be dangerously charged).
- Make certain that the measurement cables are in flawless condition, e.g. no damage to insulation, no interruptions in cables or plugs etc.
- Grip the test probe firmly, for example during insertion into a jack socket. Tensioning at the coil cord may otherwise cause the test probe to snap back resulting in possible injury.
- **Measuring of insulation resistance** (equivalent leakage current)
The test is conducted with up to 500 V, with a current limit of $I < 10$ mA. However, when touching the terminals (L or N), you will get an electric shock which, in turn, may lead to accidents.
Feature F01: When connecting the DUT via jacks 1 to 3, special care must be taken to avoid touching the open cables.

Leakage current measurement

During leakage current measurement it is essential to ensure that the DUT is operated at mains voltage. Exposed conductive parts may be subject to hazardous contact voltage during the test and may not be touched under any circumstances. (A mains shutdown takes place when the leakage current exceeds approx. 10 mA).



Attention!

The function test may only be performed after the DUT has successfully passed the safety test!

The measuring and test instrument may not be used:

- If it demonstrates visible damage
- With damaged connector cables, measuring cables or patient ports
- If it no longer functions properly
- After extraordinary stresses due to transport

In such cases, the instrument must be removed from operation and secured against unintentional use.

Meanings of Symbols on the Instrument

The symbols on the instrument have the following meanings:



Warning regarding dangerous electrical voltage



Warning concerning a point of danger (attention: observe documentation!)



Test socket



VDE testing authority approval mark



This device may not be disposed with the trash. For further details on the WEEE marking, please refer to our website www.gossenmetrawatt.de and enter search key 'WEEE'.

3 Initial Start-Up

3.1 Connection to the Mains (230 V, 50 Hz)

- Connect the mains plug at the test instrument to the mains power outlet. The function selector switch can be set to any position. If a mains outlet (earthing contact outlet) is not available, or if only a 3-phase outlet is available, the adapter socket can be used to connect the phase conductor, the neutral conductor and the protective conductor. The adapter socket has three permanently attached cables and is included with the KS13 cable set



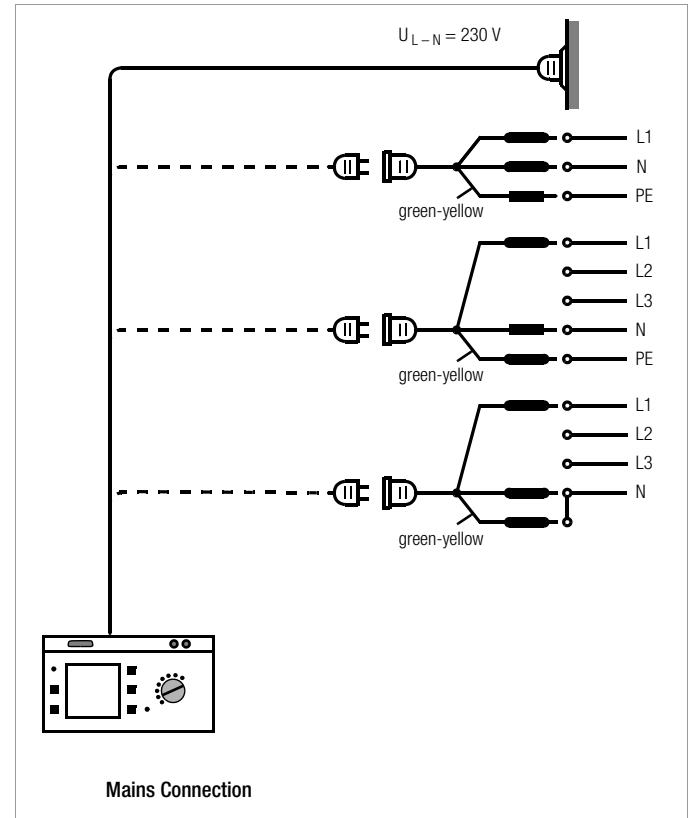

Attention!

If connection is not possible via an earthing contact outlet: Shut down mains power first. Then connect the cables from the coupling socket to the mains using pick-off clips in accordance with the diagram. Disconnection from mains power is only possible with the mains plug.



3.2 Automatic Recognition of Mains Connection Errors

The device automatically recognizes mains connection errors if the conditions in the following table have been fulfilled. The user is informed of the type of error, and all measuring functions are disabled in the event of danger.

Type of Mains Connection Error	Message	Condition	Measurements
Voltage at protective conductor PE to finger contact (⇐ key)	Text appears at LCD	Press ⇐ key $U > 40 \text{ V}$	disabled
Protective conductor PE and phase conductor L reversed and/or neutral conductor N interrupted	 lamp lights up	Voltage at PE $> 65 \text{ V}$	impossible (no supply power)
Contact voltage at protective conductor PE to neutral conductor N or phase conductor L	Text appears at LCD	$U > 25 \text{ V}$	disabled, although disabling can be deactivated ¹⁾
Mains voltage too low	 lamp lights up	$U_{L-N} < 90/180 \text{ V}$	possible under certain circumstances

¹⁾ In SETUP – test sequence – IT system



Attention!

In either of the first two cases listed in the table above, immediately disconnect the test instrument from the mains and eliminate the error!



Note

Voltage at the electrical system's protective conductor PE may result in distorted measurement values during testing for the absence of voltage, or during leakage voltage measurements.

4 General Notes

4.1 Online Instructions

The performance of measurements and tests is quick and easy with the SECUTEST®SII. Integrated online instructions inform the user regarding all required connections, necessary work steps, operator errors, measurement results and more in all measuring modes. Information and test results appear at the dot matrix LCD in plain text.

4.1.1 Automatic Safety Class Selection

Depending upon the type of mains plug or the connection configuration for the device under test, the test instrument recognizes the respective safety class and recommends its use for the measurement to be performed.

4.1.2 Manual or Automatic Operating Sequences

Depending upon selections made in the setup menu (selector switch in the Auto position), the next measurement is started automatically after the current measurement has been completed, or can only be started after manual acknowledgement. The integrated online instructions are adequate for most tests and measurements. However, the contents of these operating instructions should nevertheless be read and observed.

4.2 Online Help

Online help can be queried and displayed at the LCD for all measuring and test functions, and for almost all settings. Schematic diagrams which illustrate proper connection of devices under test to the SECUTEST®SII can be displayed as well.

⇨ Press the following key in order to query online help:



⇨ Press the same key again in order to exit online help.



Note

Online help can be queried during measurement by pressing and holding the help key.

4.3 Adjusting Contrast

MENU



Set the selector switch to **MENU**.



Select the **Setup** menu, “back” is highlighted.



Activate contrast adjustment.



Press and hold the key.



Adjust contrast.



Return to the menu.

Store the contrast setting to permanent memory with the save function in the setup menu.

4.4 Configuring Device Parameters, Setting Date and Time

Device parameters and functions which are valid for all selector switch positions can be activated or deactivated with the selector switch in the **MENU** position using the **Setup** parameter (see chapter 8 on page 15).

4.5 Configuring Measurement and Sequence Parameters

Measurement and sequence parameters, as well as functions, can be activated or deactivated in the **Setup** menu (selector switch in the **VDE** position) for the respective test regulation. Refer to chapter 11.3 on page 27 for the significance of the various parameters.

4.6 Setting Limit Values

Upon delivery, the limit values set forth (at the point in time of issue) in applicable national and international standards are stored to the test instrument. Limit values for each of the respective standards can be queried and changed if required with the **Setup > Limit Values** menu (selector switch in the **VDE...** position), but changes can only be made which result in even stricter testing than is required by the respective standard.

Newly entered limit values become effective immediately. However, these are only stored to memory permanently after activating the **Store** function in the **Setup** menu for the respective standard.

If the limit values set forth in the standards for certain safety classes need to be restored despite individualized settings, the **All Values per Standard** menu function in the **Limit Values** submenu must be selected and acknowledged with the Enter key.

If the limit values set forth in the standards are changed, the instrument's device software can be updated via the RS 232 interface.

4.7 Saving the Settings

All of the settings and changes which have been entered to the **Sequence**, **Limit Values** (selector switch in the **VDE...** position) and **Zero Point (temperature measurement)** (selector switch in the **MENU** position) menus, as well as the selected **contrast** setting are retained until the selector switch is turned, or the test instrument is disconnected from mains power. If settings and changes should be retained even after mains power has been interrupted, they must be saved in the **Setup** menu for the respective test regulation or selector switch position (acknowledge the “Save” function).

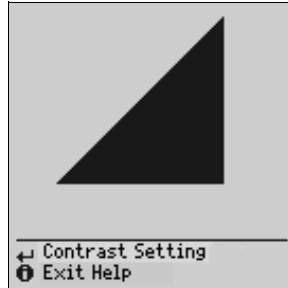

5 Classification of Devices Under Test

5.1 Safety Classes

Devices assigned to all of the following safety classes are equipped with basic insulation, and provide for protection against electrical shock by means of various additional precautions as well.

Safety Class I Devices

Exposed, conductive parts are connected to the protective conductor so that they are not charged with voltage if the basic insulation should fail.

Safety Class II Devices

These devices are equipped with double insulation or reinforced insulation.

Safety Class III Devices

These devices are powered with safety extra-low voltage (SELV). Beyond this, no voltages are generated which exceed SELV. These devices may not be connected to the mains.

Note: The DUT may only be connected to the test instrument at jacks 1 through 3 (Feature F01). Only a visual inspection, an insulation resistance measurement or a measurement of the supply voltage can be performed, see parameter “SC III U_V” on page 27.

Parameter Classification (in the Sequence... menu)

The SECUTEST®SII always tests in accordance with the strictest limit values of the respectively selected safety class. The test is failed if this limit value is exceeded. However, devices under test exist for which higher limit values are allowable.

If parameter classification is activated (= x), the user is asked if higher limit values are allowable for the DUT. If “Yes” is entered, reevaluation ensues and the DUT may pass the test.

Examples

If the insulation resistance test is failed, or if interference suppression capacitors have been replaced, equivalent leakage current measurement must be performed on DUTs with heating elements in accordance with DIN VDE 0702.

The test is failed by a DUT with 300 kW with deactivated classification function (= $_$), but it is passed with activated classification function (= x) if the question is answered accordingly.

Similar possibilities for passing the test, although it might otherwise be failed, are included in DIN VDE 0701, part 1.

If the DUT is connected via the jacks instead of the test socket, other limit values apply because higher power consumption is possible in this case (e.g. part 1 specifies a limit value of 1 mA per kW for equivalent leakage current). See also table: “Maximum Allowable Limit Values for Equivalent Leakage Current in mA” on page 20.

5.2 Application Parts (electrical medical devices)

Type B Application Parts (body)

Devices of this type are suitable for both internal and external patient applications, except for use in direct proximity to the heart.

These devices provide for adequate protection against shock especially as regards:

- Reliable leakage current
- Reliable protective conductor connection if utilized

Devices of the following safety classes are allowable: I or II.

Type BF Application Parts (body float)

Same as type B, but with type F insulated application parts.

Type CF Application Parts (cardiac float)

Devices of this type are suitable for use directly at the heart. The application part may not be grounded.

Devices of the following safety classes are allowable: I or II.

6 Abbreviations

AE	Error condition: application part grounded	R	Resistance (only with feature F01)
B, BF, CF	Classifications for application parts	R _{ISO} , R-ISO	Insulation resistance
OE	Operational earth	R-ISO APP-PE	Insulation resistance: application part to PE
ΔI	Differential current, residual current	R-ISO INT. CARD.	Insulation resistance: intracardiac (application at the heart)
ΔI _{max}	Maximum residual current (during function test)	R-ISO NL-PE	Insulation resistance: neutral/phase conductor to PE
EDL _{A1/A2}	Equivalent device leakage current with designation A1/A2 (cross-reference in the standard)	R _{PE} , R-PE	Protective conductor resistance
EDL _{PX±PE}	Equivalent device leakage current for portable x-ray +PE: with additional PE conductor -PE: without additional PE conductor	R-SL±Mains	Protective conductor resistance limit value for +mains: DUT with mains power cable -mains: DUT without mains power cable (protective conductor resistance limit value for mains power cable only = 0.1 Ω)
EDL _{SCII}	Equivalent device leakage current for devices with additional safety class 2 components	S	Apparent power
HE	Error condition: housing grounded	SELV	Safety extra-low voltage
I _L , I _≅ , I _{HL} , I _{probe}	Leakage current (differential, probe or contact current)	SFC	Single-fault condition
I _{Re}	Residual current	PE	Protective conductor
I _{EL} , I _{EDL}	Equivalent device leakage current	U _{AC/DC}	AC/DC voltage (only with feature F01)
I _{PE}	Earth leakage current (current at protective conductor)	U _{REF}	Reference voltage: voltage to which all leakage voltages make reference (as a rule nominal line voltage)
IT system	The IT system has no direct contact between active conductors and grounded parts: bodies within the electrical system are grounded.	U-ISO	Test voltage for insulation measurement
I _{Lmax}	Maximum load current (during function test)	U _{L-N}	Line voltage
I _Z	Current at clip-on meter	U _{MEAS}	Voltage with which testing was executed. Displayed for all leakage current measurements.
L	Phase conductor	U _{probe}	Probe voltage
PF	Power factor	t	On-time
MedGV	German medical device ordinance	Temp	Resistance temperature (only with feature F01)
MPG	German medical product law	W	Electrical energy
MSELV	Medical safety extra-low voltage	ZVEH	General Association of German Electricians
N	Neutral conductor		
NC	Normal conditions		
P	Active power		
PA	Functional earth (equipotential bonding)		

7 Connecting the Device Under Test

- Connect the DUT in accordance with the schematic diagrams included in the online help function.

Connection of the DUT to the test instrument depends upon:

- Type of connection:
 - With plug (“to test socket” parameter), applies to EL1 adapter as well
 - Without plug, single or multi-phase connection (“to jacks” parameter), only with feature F01
 - No connection to tester (“permanent connection” parameter)
- Whether or not an adapter is used:
 - Adapter to socket (customer specific adapter)
 - AT3-med to socket, adapter for devices which are equipped with 5-pole, 16 A CEE plugs
 - AT3-III to socket, adapter for devices which are equipped 5-pole, 32 A CEE plugs, see AT3-III operating instructions for test sequence.
- The DUT’s safety class (I, II or III)



Note

The DUT must be switched on for all tests. Switches, relays, temperature regulators etc. must all be taken into consideration.

The test instrument automatically recognizes whether or not the DUT is connected to jacks 1 through 3. If the instrument is equipped with feature B00, 01 or 03, the instrument also recognizes whether or not a DUT has been connected to the test socket. As a default setting, the program sequence assumes that the plug from the DUT has been connected to the test socket.







Note

Safety Class II Devices with Safety Class I Mains Plugs

If the device under test is equipped with a safety class I plug although it complies with safety class II, safety class I is recognized by the test instrument. If this is the case, switch from safety class I to safety class II in the initial menu.

If the test instrument is unable to automatically recognize how the DUT has been connected, the recommended connection setup should be double checked and determined manually if necessary.

- Position the  cursor at the second line in the start menu for the test sequence.
- A selection of possible connection setups can be displayed by activating the  key.
- Select the desired connection setup with the  cursor and acknowledge with the  key.

Omitting the Protective Conductor Test in the Case of Fully Insulated Devices

You are testing a fully insulated safety class I device (e. g. screen, submersible pump, etc.), which is not equipped with an external protective conductor contact.

The decision as to the necessity of a protective conductor test in this case is to be taken by a qualified electrician who should also assume responsibility.

You can omit the protective conductor test by pressing the key  as soon as the following instruction is shown: „Please connect the probe with the protective conductor of the DUT“.

Protective Conductor and Insulation Resistance Measurements for Permanently Installed Devices Under Test



Attention!

Deactivate the electrical system which supplies power to the device under test before connecting the test instrument!

-
- Remove the mains fuses from the device under test and disconnect the neutral conductor N inside the device under test.

Measuring Contact Current (absence of voltage)

Make sure that the contacted parts are not grounded.

8 Configuring Device Parameters

MENU



General device parameters can be configured and saved using **Setup** with the selector switch in the **MENU** position.



Select Setup/Menu and acknowledge.



Select parameter and acknowledge, change setting and acknowledge.

Settings x / - ... = function activated / deactivated

Limit values ...

Illumination	Background illumination for the LCD. One of three different conditions can be selected with the up and down scroll keys: x: continuously on, -: off Numbers 1 through 9: duration in minutes after which illumination is automatically deactivated.
Test time	Duration of a single test (0 ... 255 s)
Reference voltage:	Voltage to which leakage current makes reference (as a rule nominal line voltage)
Earth fault	During the short-circuit test, testing is also performed to determine whether or not a connection exists between L/N and PE (short-circuit to exposed conductive part). We assume that a short-circuit to an exposed conductive part exists in the event of leakage current greater than 15 mA from L/N to PE. This value should be increased for some DUTs (in particular high-current consumers), because greater leakage currents are present.

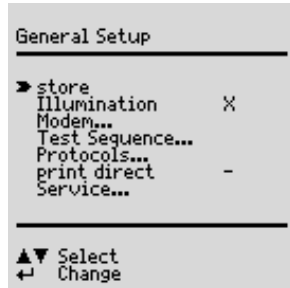

Mains wait

Line voltage is initially applied to the test socket. However, testing does not begin until after the number of seconds selected in "Mains wait" has elapsed, e.g. in order to suppress measured values during the warm-up phase.

Modem...

Modem function available upon request

Test Sequence ...

Settings x / - ... = function activated / deactivated

Single-fault

If the single-fault condition has been activated, the test is interrupted as a failure as soon as an error occurs.

Auto Class PSI

Test results (passed or failed) for the various selector switch positions are automatically assigned to the 8 statistics channels.

inc. Service Error

Measurement results are compensated by taking service error into consideration (measuring error).

IT Network

Testing in IT systems can be performed by suppressing tests for U_{PE-N} . The U_{PE-N} test determines whether or not voltage is present at PE. (Leakage current measurement results may otherwise be distorted.)

Acst Sig, Seq

An acoustic signal is generated for: incorrect connection of the DUT, error in the electrical supply system and the next test step.

Acst Sig, Meas

An acoustic signal is generated for: measured value fluctuations and test current polarity reversal.

Auto Point

This function can be enabled with the help of an upgrade program, e.g. Z745K (see chapter 13 on page 38). An acoustic signal indicates whether or not the probe is connected to the protective conductor.

The test sequence is run automatically.
Rapid signal frequency: probe connected

Slow signal frequency: next measuring point

Direct Printing

See chapter 15 on page 39.

Reports ...

Reports which have been saved to memory can be selected from a list with an ID number and displayed (see chapter 14.2 on page 39).

Service ...

– Time and date settings

(if a printer module is used, the same time and date must also be entered to the PSI- menu)

– Service functions (password required)

9 Individual Measurements

MENU



9.1 Measuring Protective Conductor Resistance

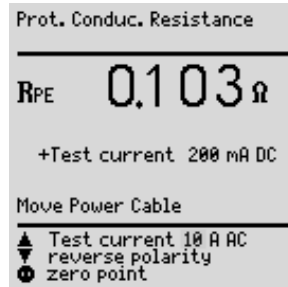

Definition

Protective conductor resistance is the sum of the following resistances:

- Connector cable or device connector cable resistance
- Contact resistance at plug and terminal connections
- Extension cable resistance if utilized

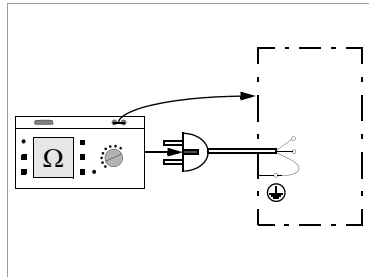

Resistance is measured:

- Between each exposed *conductive part of the housing* and the earthing contacts at the mains and the device plug (if a removable mains connector cable is used), or the protective conductor terminal for permanently installed devices.
- As a 4-pole measurement
- Between the earthing contacts at the mains plug and the earthing contacts at the device plug for *device connector cables*
- Between the earthing contacts at the mains plug and the earthing contacts at the coupling socket for *extension cables*

Connecting Safety Class I Devices to the Test Socket

When the DUT is connected, resistance is measured between the protective conductor terminal at the test socket or at the PE jack, and the probe connection at the DUT (contact with conductive parts of the housing).

- In order to measure protective conductor resistance, contact a conductive part of the housing with the probe, which is connected to the protective conductor.

During measurement, the **connector cable** must only be moved to the extent it is accessible during repair, modification or testing.

If a change in resistance occurs during the manual test step of the continuity test, it must be assumed that the protective conductor is damaged, or that one of the connector contacts is no longer in flawless condition.

Testing Extension Cables

See test sequence in chapter 11.7 on page 34.



Note

“DUT connection: SC I/II” is not displayed when the test is performed individually, but rather only during the automatic test sequence.

Combined Test – Differential Protective Conductor Resistance

Zero balancing is also possible for protective conductor measurement. With zero balancing, all subsequent measurements are adjusted with an offset such that 0Ω is displayed for a selected reference point which is connected to the protective conductor. When test points are contacted with the probe which are electrically connected to this reference point, differential resistance ΔR_{PE} between the reference point and the contacted test point is displayed.

The mains release key  must be activated during measurement in order to perform zero balancing. The acquired value can either be applied (the value remains in memory until the instrument is disconnected from mains power), permanently saved or deleted.

Maximum Allowable Limit Values for Protective Conductor Resistance for Connector Cables with Lengths of up to 5 m

Test Standard	Test Current	Open-Circuit Voltage	R_{PE} Housing – Device Plug	R_{PE} Housing – Mains Plug
VDE 0701 Part 1:2000 VDE 0702:2004 VDE 0751:2001	> 200 mA $\overline{=}$	4 V < U_L < 24 V		0.3Ω ¹⁾
				+ 0.1Ω ²⁾ for each additional 7.5 m
VDE 0751:2001			0.2 Ω	

¹⁾ This value may not exceed 1Ω for permanently connected data processing systems (DIN VDE 0701, part 240).

²⁾ Total protective conductor resistance: max. 1Ω

9.2 Insulation Resistance R_{ISO}

Definition

Safety Class I

Insulation resistance is measured between short-circuited mains terminals and the protective conductor.

Safety Classes II and III

Insulation resistance is measured between short-circuited mains terminals and external conductive parts which can be contacted with the probe.

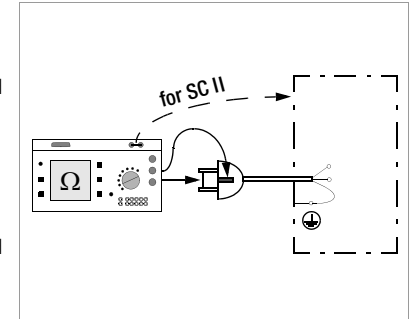

Exception for Permanently Installed Safety Class I Devices



Attention!

Deactivate the electrical system which supplies power to the device under test before connecting the test instrument!

- Remove the mains fuses from the device under test and disconnect the neutral conductor N inside the device under test.
- Connect the probe to phase conductor L at the device under test in order to measure insulation resistance.

Sequence



Note

All switches at the device under test must be set to the on position during measurement of insulation resistance, including temperature controlled switches and temperature regulators as well. Measurement must be performed in all program stages for devices equipped with program controllers.

R-ISO



Start measurement.

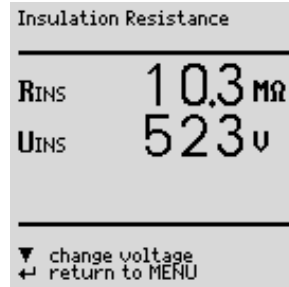

Nominal voltage is 500 V DC in this case.

Nominal voltage can be adjusted within a range of 50 V to 550 V DC.



Note

When insulation measurement is first started from the menu, nominal voltage is always set to 500 V. Open-circuit voltage is always greater than nominal voltage.

Minimum Allowable Limit Values for Insulation Resistance

Test Standard	Test Voltage	R _{ISO}			
		SC I	SC II	SC III	Heat
VDE 0701 Part 1:2000	500 V	1 MΩ	2 MΩ	0.25 MΩ	0.3 MΩ *
VDE 0702: 2004		1 MΩ	2 MΩ	0.25 MΩ	0.3 MΩ *
		2 MΩ	7 MΩ		
VDE 0751: 2001		70 MΩ	70 MΩ		

* with activated heating elements
(if heating power > 3 kW and R_{ISO} < 0.3 MΩ: leakage current measurement required)

Notes Concerning Test Standard 0702

If the measured value is less than 0.3 MΩ for safety class I devices which include a heating element, equivalent leakage current must be measured as described in chapter 9.4 on page 20, and this test must be passed. The same applies to mains powered safety class II electronic devices if the required value of 2 MΩ is not complied with.

All exposed, conductive parts of safety class II and III devices, as well as of battery-powered devices must be scanned with the probe and insulation resistance and/or leakage current must be measured.

Batteries must be disconnected from their terminals during testing of battery powered devices.

9.3 Measuring Leakage Current



Attention!

During leakage current measurement it is essential to ensure that the DUT is operated at mains voltage. Exposed conductive parts may be subject to hazardous contact voltage during the test and may not be touched under any circumstances. (A mains shutdown takes place when the leakage current exceeds approx. 10 mA).

Select the I_{xx} measurement and start.

Each time line voltage is applied to the test socket, L and N are reversed, if this function has been selected in the leakage current menu (see chapter 9.3 on page 19).

Frequency response is taken into consideration in accordance with the diagram to the right when leakage current is measured.

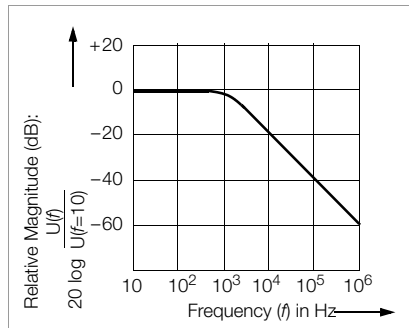

9.3.1 Contact Current I_{Contact} (probe current, housing leakage current)

Current which flows from housing parts which are not connected to the protective conductor via an external conductive connection to earth or another part of the housing. Flow of current via the protective conductor is excluded in this case.

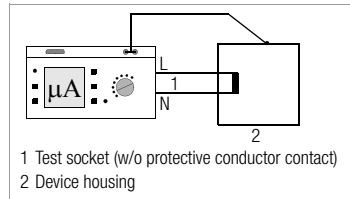

The current's AC component is measured. The DC component can also be measured by means of individual measurement (but not with a test sequence).

9.3.2 Residual Current ΔI

Sum of instantaneous current values which flow via the L and N conductors at the device mains connection (also known as differential current). Residual current is practically identical to fault current in the event of an error. Fault current: Current which is caused by an insulation defect, and which flows via the defective point.

Attention: Residual current also includes contact current.

9.3.3 Device Leakage Current I_{DL} per DIN VDE 0751

Device leakage current is determined by means of differential current measurement.

Maximum Allowable Limit Values for Leakage Current in mA

Test Standard	I_{PE}			I_{Contact}		ΔI	I_{DL}	
	NC	SFC	NC	SFC				
VDE 0701-1: 2000	SC I: 3.5 1 mA/KW *			0.5		SC I: 3.5 1 mA/KW * SC II: 0.5		
VDE 0701-240				0.25				
VDE 0702: 2004	SC I: 3.5 1 mA/KW *			0.5		3.5		
VDE 0751: 2001							General	0.5
							Notes 1 & 3	2.5
							Note 2	5.0
							SC II	0.1

* for devices with a heating power > 3.5 kW

- Note 1: Devices which do not have any exposed conductive parts which are connected to the protective conductor, and which correspond with I_{DL} and, if applicable, I_{PL} , e.g. data processing equipment with shielded power pack
- Note 2: Permanently connected devices with protective conductor
- Note 3: Portable x-ray devices with mineral insulation

Key

- I_{Contact} Housing leakage current (probe or contact current)
- ΔI Residual current
- I_{DL} Device leakage current

9.4 Equivalent Leakage Current

General

Measurement of equivalent leakage current is required for:

- DIN VDE 0701 and 0702, after passing the insulation test

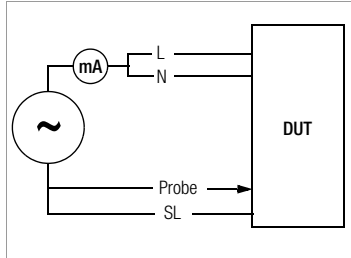

Equivalent Device Leakage Current I_{EDL} (DIN VDE 0751)

Measurement of equivalent device leakage current is required for:

- Electrical medical devices in accordance with DIN VDE 0751, part 1

Test Setup

A high-impedance power supply is connected between the short-circuited mains terminals and all exposed metal parts of the housing (which are connected to one another).

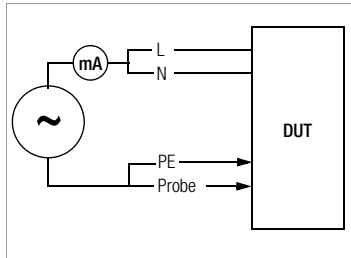

Measurement

Current which flows over the insulation at the device under test is measured.

Maximum Allowable Limit Values for Equivalent Leakage Current in mA

Test Standard	I_{EL}	I_{EHL}
VDE 0701-1: 2000	SC I: 3.5 1 mA/kW ¹⁾ SC II: 0.5	
VDE 0702: 2004	3.5 1 mA/kW ¹⁾	
VDE 0751: 2001		SC II 0.2 ²⁾
		SC I (PE or parts connected to PE) 1
		Permanently connected devices with PE 10
		Portable x-ray devices with additional PE 5
		Portable x-ray devices without additional PE 2
		Devices with mineral insulation 5

I_{EL} Equivalent leakage current

I_{EHL} Equivalent housing leakage current

PE Protective conductor

¹⁾ For devices with heating power of greater than 3.5 kW

²⁾ This limit value is not taken into consideration in the DIN VDE 0751 standard.

Connection

Refer to the schematic diagrams included with the online help for connection instructions.

Connection Exception for Permanently Installed Safety Class I Devices

Current is measured between the probe, with which the L and N conductors must be contacted, and the protective conductor terminal PE at the device under test for permanently installed safety class I devices under test.



Attention!

Disconnect mains power before connecting the test instrument!

- ⇒ Remove the mains fuses from the device under test and disconnect the neutral conductor N inside the device under test.
- ⇒ Connect the probe to phase conductor L and neutral conductor N at the device under test in order to measure equivalent leakage current.

Connection Exception for Multi-phase Devices

Equivalent leakage current measurement is not appropriate for multi-phase devices.

Sequence

Current, which would flow during leakage current measurement conducted in accordance with device regulations and with nominal line voltage, is displayed during this type of equivalent leakage current measurement.

Leakage current measurement in accordance with the respective device regulations is usually not possible, because the device would have to be set up in an electrically isolated fashion, or connected to an earth isolated power supply to this end.

Equivalent Leakage Current I_{EL} DIN VDE 070x / 2 K



Select the **I-EL** measurement and start.

Equivalent leakage current is measured between short-circuited N and L, and the **protective conductor PE**.

Measuring circuit resistance is equal to 2 k Ω for VDE 0701/0702 for simulation of mean body resistance of a human being.

Equivalent Device Leakage Current I_{EDL} for VDE 0751 / 1 K



Select the **I-EDL** measurement and start.

Equivalent device leakage current is measured between short-circuited N and L, and the **probe**.

Measuring circuit resistance is equal to 1 k Ω for VDE 0751 for the simulation of mean patient resistance.

9.5 Probe Voltage U_{probe} – Max. 300 V

Voltage is measured between the mains PE terminal at the test instrument and the probe. In this case the probe can also be used as a phase finder.



Start the U_{probe} measurement.

Probe Voltage normal condition		N/L
U_{\sim}		0.0 v
U_{\dots}	-	0.2 v
U_{\approx}		0.2 v

▲ SFC Conditions
CAT II, max. 300V $\frac{1}{2}$
← return to MENU

9.6 Alternating / Direct Voltage $U_{AC/DC}$ – Max. 253 V (feature F01)

Direct, alternating and pulsating voltages of up to 253 V can be measured between the N (2) and L (3) connector jacks.



Select the $U_{AC/DC}$ measurement and start.

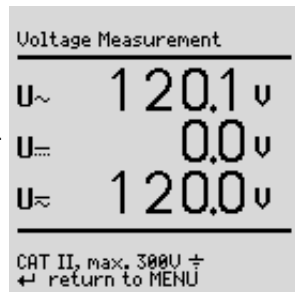

9.7 Resistance R (feature F01)

Resistance of up to 150 k Ω can be measured between the PE (1) and N (2) connector jacks.



Select the R measurement and start.

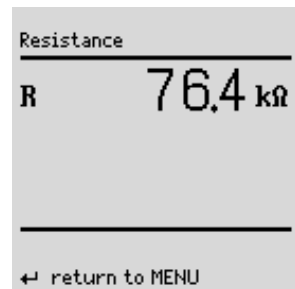

9.8 Measurements with Accessories (feature F01)

9.8.1 Alternating Current I_z with Clip-On Transformer (feature F01)

Connection

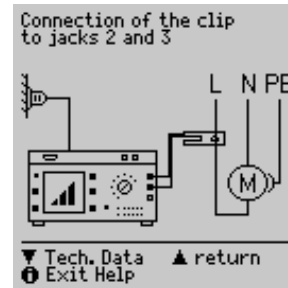

Alternating current can be measured in two measuring ranges (1 mA ... 10 A ~, 1 A ... 100 A~) with a clip-on current-voltage transformer connected to the N (2) and L (3) jacks (e.g. the WZ12C).



Start the I_z measurement.



Select measuring range.

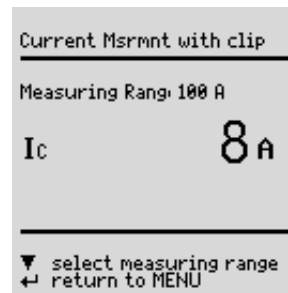

9.8.2 Temperature T with Pt100/1000 Sensor (feature F01)

Connection

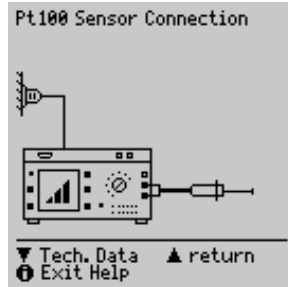

Temperature can be measured within a range of $-200\text{ }^{\circ}\text{C}$ to $+850\text{ }^{\circ}\text{C}$ with a Pt100 or Pt1000 sensor (default setting) connected to the PE (1) and N (2) jacks.



Select the **Temp** measurement and start. Select Pt100 or Pt1000 by means of “select measuring range” with the ∇ key. The temperature unit of measure can be selected in the “TEMPERATURE” Δ setup menu. Selection can be made amongst $^{\circ}\text{C}$ (Celsius), $^{\circ}\text{F}$ (Fahrenheit) or Kelvin. Zero balancing is also accessible via the “TEMPERATURE” setup menu.

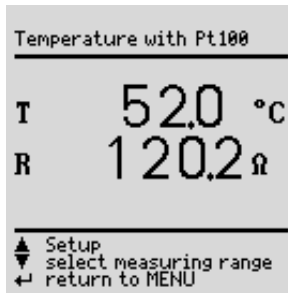

Zero Balancing

Sensor cable resistance can be compensated with this function:

- ⇒ Short circuit the ends of the sensor leads and determine resistance as shown below.

Zero Balancing



The determined value can be stored directly (Δ key) or changed first. The data entry menu is opened with the ∇ key.

- ⇒ Change the measured value manually with the help of the Δ and ∇ keys.
- ⇒ Press the \square key in order to acknowledge the selected value, and to display other menu functions at the bottom of the window.

Save the selected value by activating the “store value” key Δ before exiting the balancing function with the \square key.

The “delete value” command can only be accessed via the “change value” menu. The “no zero balancing” setting is saved at the same time by activating the ∇ key.

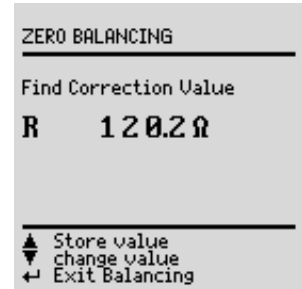

10 Function Test



Function Test

The device under test can be subjected to a function test with line voltage via the integrated test socket.

In addition to testing with the selector switch in the function test position, or with the **Function** parameter in the **MENU** position (feature F01 only), a function test can also be performed immediately after safety testing has been passed in accordance with the selected standard (not possible for safety class III devices).



Attention!

The function test may only be performed after the DUT has successfully passed the safety test.



Note

Each time line voltage is applied to the test socket, phase conductor L and neutral conductor N are automatically reversed, if the “mains polarity reversal” function has been activated (= x) in the **I leakage** selector switch position.



Note

The function test is only possible if the device under test has been connected to the test socket (21).

Measurements

The function test includes the following measurements:

- Voltage U-LN between the L and N conductors
- Residual current ΔI
(corresponds to fault current between L and N)
- Load current I_L
- Active power P
- Apparent power S (calculated)
- Power factor PF ($\cos \varphi$ calculated, display > 10 W)
- Electrical energy W
- On-time t for U_{L-N} at the socket (21)

The following values are also displayed for all selector switch positions except MENU, after the function test has been completed:

- Maximum residual current ΔI_{\max}
- Maximum load current $I_{L\max}$
- Maximum active power P_{\max}

Power factor is calculated from active power and apparent power. Power factor corresponds to $\cos \varphi$ for sinusoidal quantities (line voltage and load current).



Attention! Starting the Function Test

For reasons of safety, the device under test must be switched off before the function test is started. This precaution prevents inadvertent start-up of a device under test which may represent a hazard during operation, e.g. a circular saw or a disc grinder.

Ending the Function Test

After completion of the function test, devices under test must be turned off with their own switch – especially devices with relatively high inductivity.

Short-Circuit Test

- 1 Test for shorts between conductors N and L.
- 2 Test to determine whether or not the N or L conductors are short-circuited to the protective conductor.

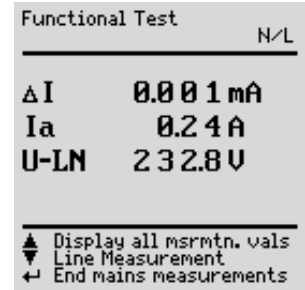
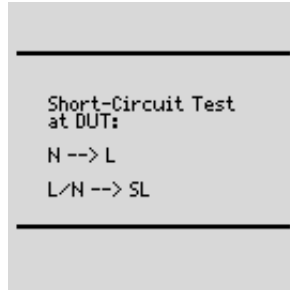

The test socket can be rendered voltage-free with the key (14), or the function test can be ended with the  key (12).



Note





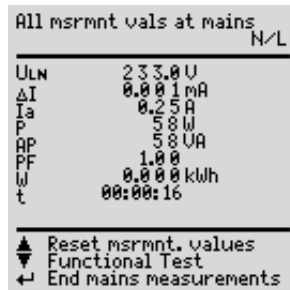

A short-circuit at the device under test is recognized automatically by the test instrument. A message appears at the display (9), and the function test is disabled.

If the  lamp blinks (15), line voltage can be switched to the test socket with the key (14), and the measurement can be started. If the lamp (15) is lit continuously, line voltage is present at the test socket.



11 Measurements – Selector Switch Settings for Standards

If measurements need to be performed in accordance with given standards which require specific tests, and if results need to be documented with a test report, an automatic test sequence is advisable instead of individual measurements.

- ⇨ Connect the SECUTEST®SII to mains power.
A **mains connection test** is initialized (see chapter 3.2 on page 10).
- ⇨ Connect the DUT to the test socket at the SECUTEST®SII (see chapter 7 on page 14). The test instrument initializes **connection type recognition**.
- ⇨ Set the selector switch  to the appropriate standard.
If the test instrument is equipped with features B00, 01 or 03, and if the DUT has been connected to the test socket, **safety class recognition** is performed. Otherwise, the safety class must be specified manually. Move the cursor up into the third line in the initial window with the  key, and acknowledge with the  key. A safety class can now be selected with the  and  keys and acknowledged with the  key.
- ⇨ The test sequence can be configured in the **Setup...** menu, limit values can be changed if necessary and database options can be selected.
- ⇨ The test sequence is started by selecting **Start test** and acknowledging with the  key (see following chapter, "Test Sequences").

Tests which have already been included in chapters 9 through 14 are not described here again. The only exception is measurement of extension cables.

11.1 Test Sequences

Test sequences for the various standards are always run in the same order, assuming that the device under test has been properly connected and the mains connection test has been passed.

The test sequence can be run step by step with manual activation of each subsequent step if this function has been specified, or automatically. Step by step manual operation can be selected if "Manual Sequence" has been activated under Sequence... in the setup menu in the initial window.

- Visual inspection: If "Visual Inspection" has been activated under Sequence...

If a part is recognized as defective by the user, it must be identified as such by selecting it with the cursor and acknowledging with the  key.

- Protective conductor measurement (for SC I devices under test only)



Note

If a protective conductor connection is not possible, the measurement can be skipped with  (when the message „Connect probe to protective conductor“ is shown on the display).

- Evaluation of protective conductor testing
- Insulation resistance measurement
DIN VDE 0751: Only if ISO-R is activated under Sequence... in the setup menu
DIN VDE 0702: Only if ISO-R is activated in the initial window
- Evaluation of insulation test
- Leakage current measurement
- Evaluation of each individual leakage current measurement
- Evaluation of the overall test
- Perform function test if required:
The function test can be performed each time a safety test has been successfully completed. The blinking signal lamp indicates that the function test should be started. Beyond this, the function test can also be started from the **Function Test** selector switch position. See chapter 10 on page 24 regarding performance of the function test.
- Display test results
(the worst measured values for the test sequence)
- Save test results and print if required

11.2 Setting Up Test Sequences

All possible sequence settings for all of the regulations are listed below.



Select the **Setup...** menu from the initial program window and acknowledge

Repair tests, periodic testing

Save	All of the settings in the setup menu, i.e. configuration of measuring parameters and current limit values, can be saved with this command. These values remain active even after setting the selector switch to a different position, and after disconnection from mains power.
Sequence ...	See page 27.
Limit values ...	See chapter 4.6 on page 11.
Database ...	

Start with ID No.

x: Before each measurement is started, an entry prompt appears requesting entry of an ID no. An individual number can be entered (max. 20 characters) with the keypad at the PSI module (optional), read in with a barcode scanner (optional) or directly selected from a list. If an incorrect entry is made:

Only complete lines can be deleted, and deletion is only possible with the  key at the instrument.

ID no. = test sequence (feature KB01 or DBmed option)

See chapter 12 on page 38.

11.3 Configuring Measuring Parameters

Depending upon the test regulation, various measuring parameters can be configured for the test sequence (settings: x / – = function activated / deactivated). All possible parameters for all of the regulations are listed below. The **Sequence ...** menu is accessed via the setup parameter in the initial program window for the respective regulation.



Select the **Sequence ...** menu and acknowledge.



Select a parameter, acknowledge, change and acknowledge the change.

General Parameters

Visual inspection	This menu appears at the very beginning of the test sequence.
Manual sequence	Each test step must be acknowledged with the  key (see test sequence in chapter 8 on page 15 regarding test duration for automatic sequence)
Auto-store	After testing is finished, test data are automatically stored to the SECUTEST®SII (feature KB01 or Dbmed option), or the SECUTEST®PSI (accessory).
Polarity reversal	L an N are reversed each time line voltage is applied to the test socket.
Classification	Questions regarding classification appear if limit values are exceeded (see chapter 5 on page 12).
SC III U _V	Supply voltage is measured instead of insulation resistance for active devices under test.
R-ISO LN-PE	Insulation resistance measurement is performed between phase/neutral conductors and the protective conductor.

Additional Parameters for DIN VDE 0702/0751

Auto test method	The instrument recognizes whether or not the device under test can be switched on: Leakage or residual current, or insulation resistance and earth leakage current, are measured accordingly
Adapter for socket	Limit values are activated for permanently connected devices. A device under test which is normally permanently installed can be connected to the test socket via an adapter. No voltage may be applied to the test socket when this test method is used.

11.4 Testing Devices in Accordance with DIN VDE 0701, Parts 1 and 200

The following measurements can be performed in accordance with the above mentioned standard:

- Protective conductor measurement R_{PE} (*permanent connection or with plug*)
 - Part 1/200: Test current: ± 200 mA DC
- Insulation resistance measurement R_{ISO}

Part 1

The following safety class I through III appliances and electrical equipment can be tested in this selector switch position, for example:

- Devices with electric motors
- Electrical heating devices
- Electrical tools
- Light fixtures

SC I extension cables can also be tested (see chapter 11.7 on page 34).

Part 200

Mains powered, safety class I through III electronic devices, e.g. consumer electronics, can be tested in this selector switch position:

- Stereo equipment, televisions

The following maximum values for equivalent leakage current apply for mains powered electronic devices per DIN VDE 0701, part 200:

- Devices with single-phase power supply: 1 mA
- Devices with multi-phase power supply: 0.5 mA

Check connection parameters and start test.

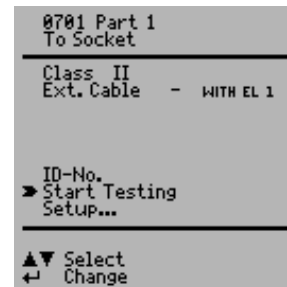

To Socket	This is the default setting. Refer to chapter 7 on page 14 for other types of connection.
Class	If the test instrument is equipped with features B00, 01 or 03, and if the DUT has been connected to the test socket, safety class recognition is performed (SC I or SC II). Otherwise, the safety class must be specified manually.
Ext. Cable	x: Extension cables or connector cables which are longer than 5 m can be tested with the help of the EL1 adapter (optional), either separately or in combination with a device.
ID No.	See parameters database in chapter 11.2 on page 27.
Setup ...	See chapter 11.2 on page 27 regarding setup of the measuring sequence.



Note

Extension cables can only be tested in the VDE 0701 part 1 and VDE 0702 selector switch positions if the EL1 accessory adapter is used (see chapter 11.7 on page 34).

Test Sequence per VDE 0701

Select connection, select test regulation **VDE 0701 part 1 or 200**, classify the DUT (SC I, II or III), **part 1: extension cable X/- (with/without)**

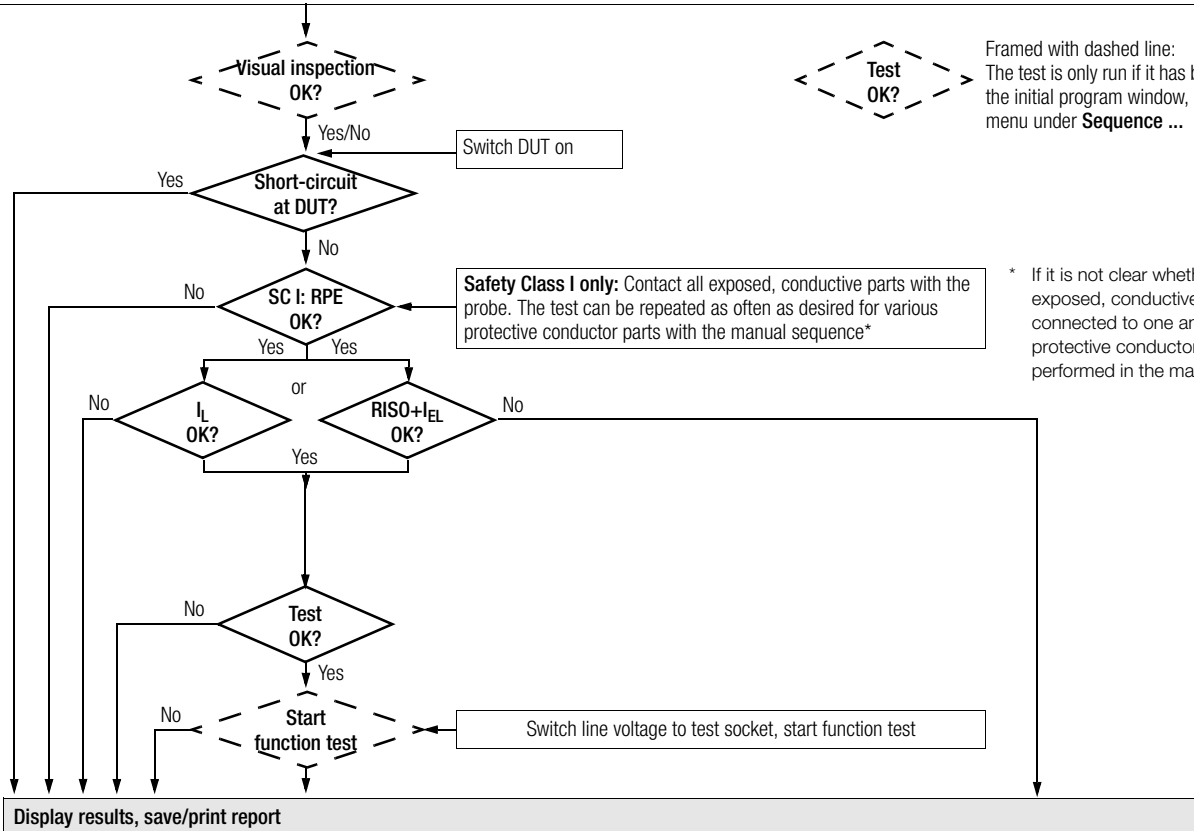

11.5 Testing Devices in Accordance with DIN VDE 0701, Part 240

Testing safety class I and II **data processing equipment and office machines** as individual devices and in combination with one another.

The following measurements can be performed in accordance with the above mentioned standard:

- Protective conductor R_{PE} (*permanent connection or with plug*)
Test current: DC ± 200 mA
 - Housing leakage current I_{\leq}
 - According to DIN VDE 0701, part 240, the device protective conductor must be tested after maintenance, repair or modification of data processing equipment and office machines, and exposed, conductive parts must be tested for the absence of voltage. This applies to:
 - Safety class I devices for all exposed, conductive parts which are accessible to the user, and which are not connected to the protective conductor
 - Safety class II devices (totally insulated devices) for all exposed, conductive parts which are accessible to the user
- with the mains plug poled in both directions

Setting Up the Test Sequence

See chapter 11.4 regarding the test sequence.

Special Parameters

Combined Testing

Safety class I and II devices can be tested individually or in combination. All protective conductor connections are tested first for interconnected safety class I devices, and then – as is also the case for interconnected safety class II devices – all exposed, conductive parts.

Connecting the Device Under Test

- ◇ Connect the test instrument and the DUT as described below:
 - Connect both devices to separate mains outlets.
The outlets to which the test instrument and the safety class I DUT are connected must share a common protective conductor!
 - Or connect the test instrument to the mains and the DUT to the test socket at the test instrument.

Data Processing / Office Machines

Permanently connected or with plug

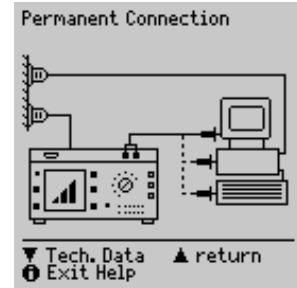

To test socket at the instrument

The requirement for **testing with the mains plug poled in both directions** can be fulfilled by connecting the DUT to the test socket at the instrument, and by activating mains polarity reversal under “Sequence” in the setup menu. Each time the key (14) is activated, phase conductor L and neutral conductor N are reversed at the test socket.

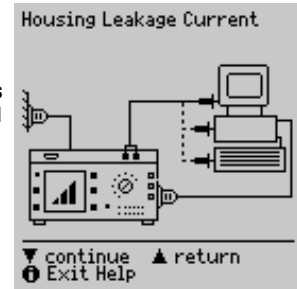

Attention!

Testing with mains polarity reversal or with the mains plug poled in both directions results in interruption of supply power to the affected data processing equipment or office machine. This test may thus only be conducted with the consent of the operator of the data processing equipment or office machine.

If the DUT is defective, the electrical system's RCCB may be tripped during testing which would also result in interruption of supply power to the affected equipment or office machine. The manufacturer of the test instrument assumes no liability for loss of data or other damage which results from use of the test instrument.

Test Sequence per VDE 0701, Part 240

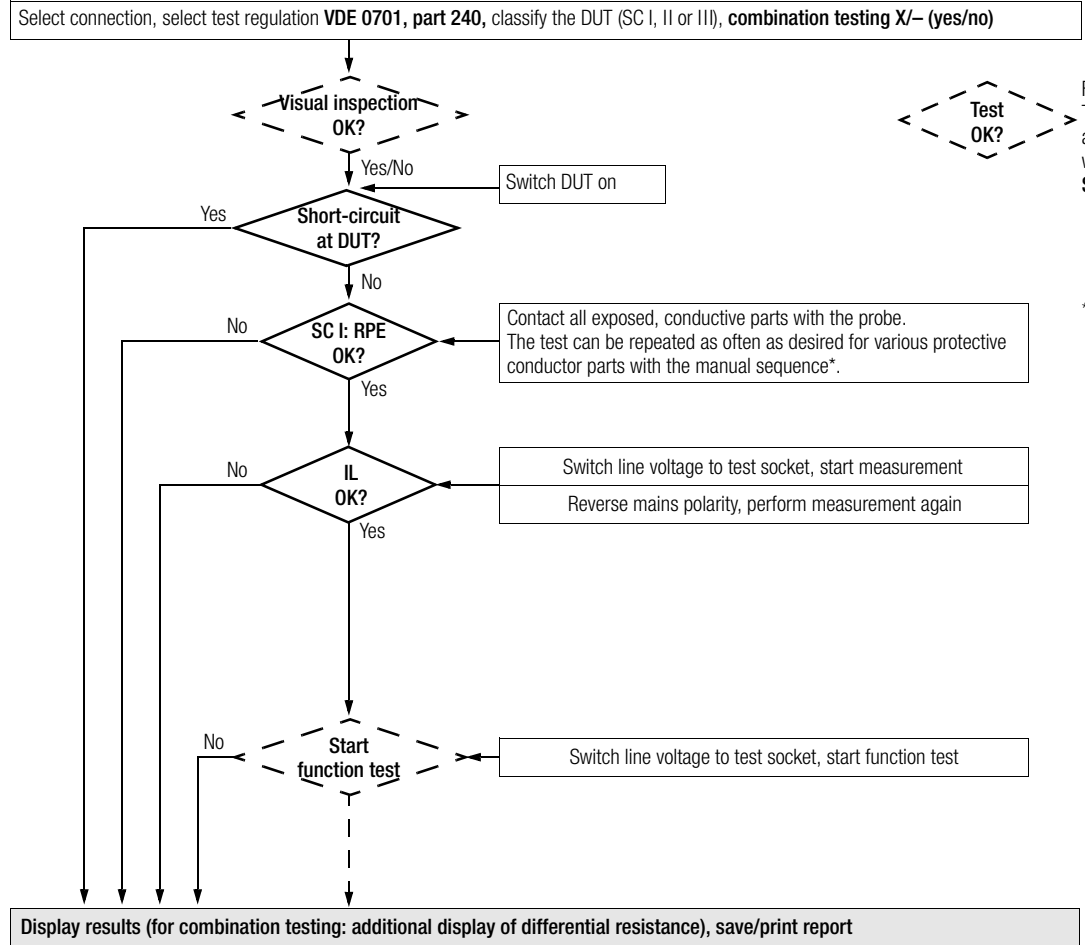

Framed with dashed line:
The test is only run if it has been activated in the initial program window, or in the **Setup** menu under **Sequence ...**

* If it is not clear whether or not all exposed, conductive parts are connected to one another or to the protective conductor, testing can be performed in the manual mode.

11.6 Testing Devices in Accordance with DIN VDE 0702:2004

The following measurements can be performed in accordance with the above mentioned standard:

- Protective conductor R_{PE} (*permanent connection or with plug*)
Test current: DC ± 200 mA
- Insulation measurement R_{ISO} (*can be deactivated, e.g. if danger exists that voltage sensitive components in data processing systems might be damaged*) plus equivalent leakage current

or

- Contact current for safety class II

or

- Differential current

Check connection parameters and start test.

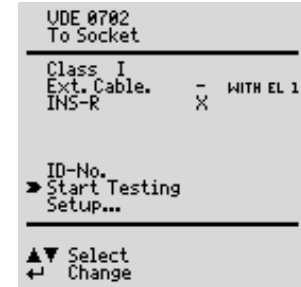

To Socket	This is the default setting. Refer to chapter 7 on page 14 for other types of connection.
Class	If the test instrument is equipped with features B00, 01 or 03, and if the DUT has been connected to the test socket, safety class recognition is performed (SC I or SC II). Otherwise, the safety class must be specified manually.
Ext. Cable	x: Extension cables or connector cables which are longer than 5 m can be tested with the help of the EL1 adapter (optional), either separately or in combination with a device.
ISO-R	x: Insulation resistance measurement is performed.
ID No.	See parameters database in chapter 11.2 on page 27.
Setup ...	See chapter 11.2 on page 27 regarding setup of the measuring sequence.

Test Sequence per VDE 0702:2004

Select connection, select test regulation **VDE 0702**, classify DUT (SC I, II or III), **extension cable X/- (with/without)**

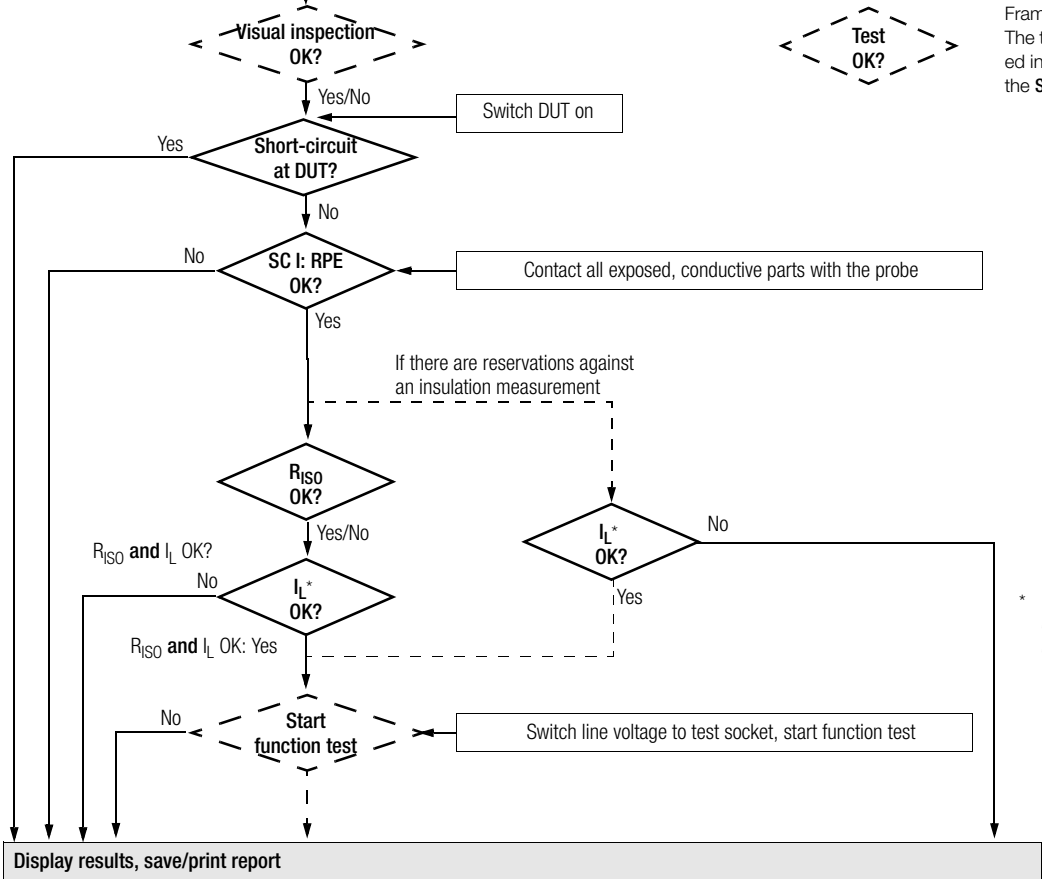

Framed with dashed line:
The test is only run if it has been activated in the initial program window, or in the **Setup** menu under **Sequence ...**

11.7 Testing Extension Cables for VDE 0701, Part 1, and VDE 0702 (option: EL1 adapter)

Extension Cables up to 5 m Long

Protective conductor resistance between the earthing contact at the mains plug and all exposed metal parts may not exceed 0.3Ω for safety class I devices. This value may not exceed 1Ω for permanently connected data processing systems (DIN VDE 0701, part 240).

Extension and Connector Cables Longer than 5 m

Per DIN VDE 0702, an additional cable resistance of 0.1Ω , however, not more than 1Ω , is allowable as of a length of 5 m for each additional 7.5 m.

Resistance testing for cables longer than 5 m is thus advisable (see also limit values on page 17).



Note

The EL1 accessory adapter is required for testing for short-circuiting and interruption of single-phase extension cables.

Connecting the Extension Cable or the Multiple Outlet

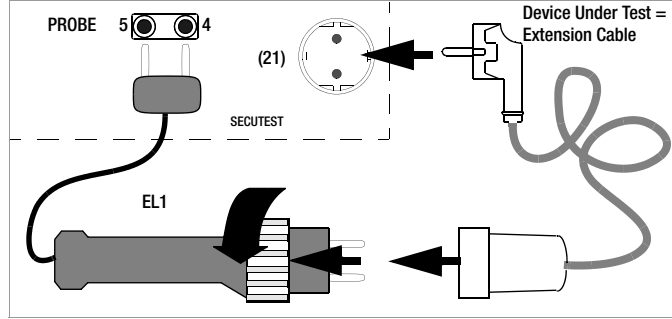

Note

The keys in the adapter's handle have no function.

Performing the Test

- Connect the extension cable to the EL1 adapter as shown in the figure above.
- Select the "Ext. Cable" test from the initial menu with the cursor and acknowledge with the key: Ext. Cable x WITH EL1.
- Select "Start Test" with the key.
- Start the measurement sequence with the key.
- First perform and acknowledge visual inspection of the extension cable.
- Enter the length of the cable with the and keys. Acknowledge with the key.

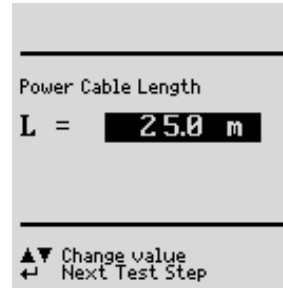

11.8 Testing Multiple Outlets for VDE 0702 (optional EL1 adapter)

- ⇨ up to version 5.10:
Do **not** select “WITH EL1” in the initial menu. The following must appear in the line: Ext. Cable – WITH EL1. “Manual sequence” must be selected.
- ⇨ from version 5.11 onwards:
Select “X WITH EL1” in the initial menu. The following must appear in the line: Ext. Cable **X** WITH EL1. “Manual sequence” must be selected.
- ⇨ A visual inspection must always be performed. It may thus be necessary to unreel the cable from its drum or reel.
- ⇨ Protective conductor resistance measurement: Contact the first outlet with the EL1 adapter. Each time you are ready to contact the next outlet, press the  key to repeat the test.
- ⇨ After measurement has been completed for all outlets, reinsert the test probe in order to continue with the performance of subsequent tests as described in chapter 11.6.

11.9 Testing in Accordance with DIN VDE 0751

The following measurements can be performed in accordance with the above mentioned standard:





- Protective conductor measurement R_{PE} , test current: 200 mA DC
- Insulation measurement R_{ISO} (*can be additionally activated*)
 - R-ISO LN-PE
(Insulation resistance LN to protective conductor)
- Equivalent device leakage current I_{EDL}
- Device leakage current (direct measurement or by means of differential current)
- Patient leakage current with probe
(Patient leakage current is not possible with SFC „Mains at Application Part“)
- Equivalent patient leakage current with probe

Leakage current is converted to reference voltage (see limit values, chapter 8 on page 15).

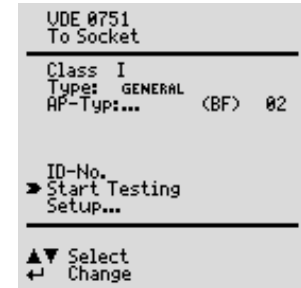
Reference voltage must be matched to the supply voltage range.

Check connection parameters and start test.



To Socket	This is the default setting. Refer to chapter 7 on page 14 for other types of connection.
Class	If the test instrument is equipped with features B00, 01 or 03, and if the DUT has been connected to the test socket, safety class recognition is performed (SC I or SC II). In all other cases, or if it is not clear whether or not all exposed, conductive parts are connected to one another or to the protective conductor, the safety class can be selected manually.
Type	Select the type of device under test from a list (device type). If “Old devices” is selected, limit values specified in DIN VDE 0702 are used.
Ap. parts...	(BF): The type of application parts can be changed manually: Select the “Ap. Parts” line with the  or  key, acknowledge with the  key and change with the  or  key.
ID No.	See parameters database in chapter 11.2 on page 27.
Setup ...	Refer to chapter 11.2 on page 27 regarding setup of the measuring sequence.

Test Sequence per VDE 0751

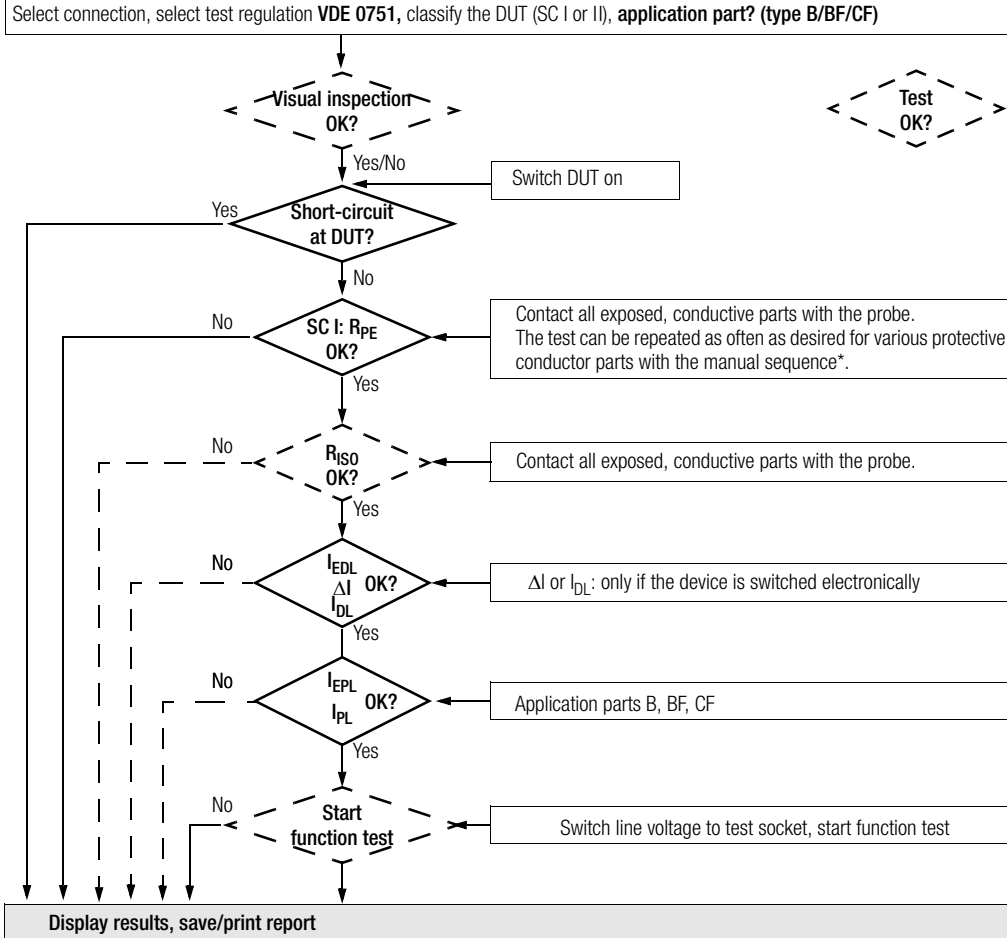

Framed with dashed line:

The test is only run

– If it has been activated in the initial program window, or in the **Setup** menu under **Sequence ...**

or

– If at all possible

* If it is not clear whether or not all exposed, conductive parts are connected to one another or to the protective conductor, testing can be performed in the manual mode.

12 Storage in PSI Module (Feature E01) and Database Operations (Feature KB01 or DBmed option)

12.1 Storing Measurement Data in the PSI Module

Upon completion of a measurement – „Test passed/Test failed“ is shown on the display – you can save the measurement data to the memory of the PSI module.

- Press the **STORE** key at the PSI module to this end.
A text entry field is shown.
- You may now enter your comments on the measurement and/or an identification number.
- Press the **STORE** key once more to save the measurement data and your comments.
The message: „Data are stored“ is displayed.

A detailed description is given in the operating instructions of your PSI module under chapter „How to display, print and store protocol“.

12.2 Database Operations

12.2.1 Setting Up Test Sequences with PC Software

This function must be activated with the help of upgrade software, e.g. the Z853H program.

Up to 99 test sequences can be uploaded for each of the selector switch positions from a PC via the serial port at the SECUTEST®SII test instrument. After testing has been performed, the test results are saved to the same database, if a PSI module has not been connected. The maximum possible sum of test sequences and test results is 127.

Test results are stored to the PSI module if one has been connected.

The database can be used in different ways:
(see also chapter 11.2 on page 27)

1. Stored test results can be displayed
(select the ID no. and then activate the “from database” function).
The desired test sequence can be selected with the scroll keys.
2. If “ID no. = test sequence” has been activated (X), the first two characters of the ID number determine the test sequence.

Example: ID number = 037890sk3r
Test sequence number 03 is executed.
Test sequence 03 is the test sequence which appears at the third position from the top of the list.

If this number does not exist, the default sequence is executed.

3. Executed test sequences are stored to memory at the instrument as test results. The test results can also be displayed at a later point in time with the “test sequence settings” submenu in the “general setup” menu.



Note

The database can only be generated or deleted with the help of a PC with a terminal program, or appropriate application software.

12.2.2 Storing Test Results to the SECUTEST®SII

This function must be activated with the help of upgrade software, e.g. the Z853H program.

If no PSI module has been connected, up to 99 reports can be stored to the test instrument. The reports can be viewed as required at the instrument and can be printed out, for example with the help of DA-II software or a terminal program.

The reports are sorted by time and date and are displayed with the ID number. If no ID number was assigned, date and time are automatically saved instead.

13 Remote Control (Feature KD01 or SK5 Option)

This function must be activated with the help of upgrade software, e.g. the Z745K program.

The protective conductor measurement is expanded to include the function: “automatic recognition of measuring point change”.
During protective conductor measurement, the instrument recognizes whether or not the probe is in contact with the protective conductor, and indicates these two possible conditions by means of different acoustic signals.

This function is helpful if several protective conductor connections need to be tested. The function can be activated with the “auto measuring point” function in the “test sequence setup” menu (see “changes to the switch position menu” above).

14 Printing via PSI Module (Feature E01) or with the Printer Adapter (DA-II accessory)

14.1 Print Out Test Data at the PSI Module

Upon completion of a measurement – „Test passed/Test failed“ is shown on the display – you can print out the measurement data via your PSI module.

- Press the **PRINT** key at the PSI module to this end. The print menu is displayed.
- Select „Protocol“ with your cursor and acknowledge with .
- Press the **PRINT** key once more to start the print-out.

A detailed description is given in the operating instructions of your PSI module.

14.2 Printing Test Results in Report Form

Test instruments can be connected to commercially available printers with the DA-II printer adapter (Z745M), even if they are not equipped with a parallel port, thus allowing for on-site print-out of test reports etc.

The only prerequisite is that the printer module is set up for direct report generation.



Note

Only printers disposing of the ASCII type font are suitable for use.

Connecting a Centronics Printer

Connect the test instrument to a Centronics printer via the RS 232 port with the help of the DA-II adapter. The PSI module may not be connected.

You can shift to the **Report** menu from any of the displayed test results (1st page) with the help of the  key.

To Socket		CL I
Test Results		Part 1
MEAS. VALUES	LIMIT VALUES	
RSL	0.098 Ω	<1.000 Ω
RINS	0.033 MΩ	>0.500 MΩ
UINS	39 U	500 U
IEHL	6.90 mA	< 7.00 mA

Passed!

← New ▲▼ Page ● Fnc.

Measurement results for the current test can be stored to memory, the results of the current test can be printed out to the corresponding report form, previously stored test results can be queried (scroll: DBmed option, see chapter 12) and all saved measurement results can be printed out from this menu.

Print-out is executed directly to the Centronics printer via printer adapter DA-II.

The matching report form is automatically selected for the standard selected with the selector switch.

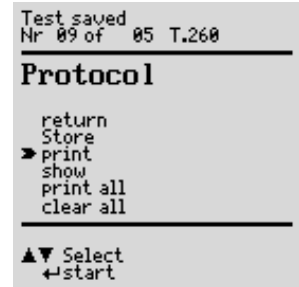

15 Direct Print-Out (feature KE01, SECU-dd option)

After completion of each test (individual test or at the end of a test sequence), test results are read out directly via the RS 232 interface. If the SE-CUTEST®PSI has been connected, the results are printed directly to paper.

Protokoll utility			
Beenden Protokoll ändern Prüfergebnis			
VDE 0751	allgemein	SK I	
1 R-SL			+0.044 Ω <0.300 Ω
EGA			+0.942 mA <0.898 mA
EPA AB (BF)			+000.0 μA <04.49 mA
EPA CD (BF)			+000.3 μA <04.49 mA
EPA EF (BF)			+000.2 μA <04.49 mA
EPA GH (BF)			+000.3 μA <04.49 mA
EPA IK (BF)			+000.2 μA <04.49 mA
VDE 0751	allgemein	SK I	
1 R-SL			+0.043 Ω <0.300 Ω
DI			+1.029 mA# <0.449 mA
Netz am Anw.Teil			
PA-NAT AB (BF)			+000.6 μA <05.00 mA
PA-NAT CD (BF)			+000.6 μA <05.00 mA
PA-NAT EF (BF)			+000.6 μA <05.00 mA
PA-NAT GH (BF)			+000.6 μA <05.00 mA
PA-NAT IK (BF)			+000.6 μA <05.00 mA
L/N			
DI			+1.031 mA# <0.449 mA
Netz am Anw.Teil			
PA-NAT AB (BF)			+000.6 μA <05.00 mA
PA-NAT CD (BF)			+000.6 μA <05.00 mA
PA-NAT EF (BF)			+000.6 μA <05.00 mA
PA-NAT GH (BF)			+000.6 μA <05.00 mA
PA-NAT IK (BF)			+000.6 μA <05.00 mA

16 Characteristic Values

Function	Measured Quantity	Measuring Range / Nominal Range of Use	Resolution	Nominal Voltage U_N	Open-Circuit Voltage U_0	Nominal Current I_N	Short-Circuit Cur. I_K	Internal Resistance R_i	Reference Resist. R_{REF}	Measuring Error	Intrinsic Error	Overload Value	Capacity Duration
Tests per DIN VDE 0701 / 0702 / 0751	Device Protective Conductor Resistance R_{PE}	0.000 ... 2.100 Ω	1 m Ω	—	4.5 ... 9 V DC	—	>200 mA DC	—	—	$\pm(5\% \text{ rdg.} + 10 \text{ d})$ > 10 d	$\pm(2.5\% \text{ rdg.} + 5\text{d})$ > 10 d	253 V	cont.
		2.11 ... 31.00 Ω	10 m Ω										
	Insulation Resistance R_{ISO}	0.050 ... 1.500 M Ω	1 k Ω	50 ... 500 V DC	1.0 • U_N ... 1.5 • U_N	> 1mA	< 10 mA	—	—	$\pm(5\% \text{ rdg.} + 10 \text{ d})$ $\pm(10\% \text{ rdg.} + 10 \text{ d})$	$\pm(2.5\% \text{ rdg.} + 5 \text{ d})$ > 10 d	253 V	cont.
		1.01 ... 10.00 M Ω	10 k Ω										
	Equivalent Leakage Current I_{EL} or I_{DL}	0.00 ... 21.00 mA	10 μ A	—	230 V~ – 20/ +10 %	—	< 3.5 mA	> 72 k Ω	1/2 k Ω ⁵	$\pm(5\% \text{ rdg.} + 10 \text{ d})$	$\pm(2.5\% \text{ rdg.} + 5 \text{ d})$ > 10 d	253 V	cont.
		20.1 ... 120.0 mA	100 μ A										
	Equivalent Patient Leakage Current I_{EPL}	0.0 ... 310.0 μ A	100 nA	—	230 V~ – 20/ +10 %	—	< 3.5 mA	> 72 k Ω	1 k Ω $\pm 10 \Omega$	$\pm(5\% \text{ rdg.} + 10 \text{ d})$	$\pm(2.5\% \text{ rdg.} + 5 \text{ d})$ > 10 d	253 V	cont.
		0.300 ... 2.100 mA	1 μ A										
	Contact Current or Housing Leakage Current I_{Probe} or I_{DL}	0 ... 310 μ A ⁶	0.1 μ A	—	—	—	—	—	1/2 k Ω ⁵	$\pm(5\% \text{ rdg.} + 10 \text{ d})$	$\pm(2.5\% \text{ rdg.} + 5 \text{ d})$ > 10 d	253 V	cont.
		0.300 ... 3.500 mA	1 μ A										
Patient Leakage Current I_{PL} AC/DC Components Measured Separately	0.0 ... 310.0 μ A	100 nA	—	—	—	—	1 k Ω	—	$\pm(5\% \text{ rdg.} + 10 \text{ d})$	$\pm(2.5\% \text{ rdg.} + 5 \text{ d})$ > 10 d	253 V	cont. 2.4	
	0.300 ... 3.100 mA	1 μ A											
Differential Current ΔI between L and N ¹	0.000 ... 3.100 mA~	1 μ A	—	—	—	—	—	—	$\pm(10\% \text{ rdg.} + 10 \text{ d})$ > 10 d	$\pm(5\% \text{ rdg.} + 5 \text{ d})$ > 10 d	2	2	
	3.00 ... 31.00 mA~ ²	10 μ A											
Function Test	Line Voltage U_{L-N}	207.0 ... 253.0 V~	0.1 V	—	—	—	—	—	—	$\pm(2.5\% \text{ rdg.} + 5 \text{ d})$	253 V	cont.	
	Load Current I_Y	0 ... 16.00 A _{RMS}	10 mA	—	—	—	—	—	—	$\pm(2.5\% \text{ rdg.} + 5 \text{ d})$	20 A	10 min.	
	Active Power P	0 ... 3700 W ³	1 W	—	—	—	—	—	—	$\pm(5\% \text{ rdg.} + 10 \text{ d})$ > 20 d	253 V	cont.	
	Apparent Power S	0 ... 4000 VA	1 VA	Calculated value $U_{L-N} \cdot I_Y$							$\pm(5\% \text{ rdg.} + 10 \text{ d})$ > 20 s	20 A	10 min.
	Power Factor LF, sinusoidal: $\cos \phi$	0.00 ... 1.00	0.01	Calculated value P / S, display > 10 W							$\pm(10\% \text{ rdg.} + 5 \text{ d})$	2	2
	Differential Current ΔI between L and N per DIN VDE 0702	0.00 ... 31.00 mA~	10 μ A	—	—	—	—	—	—	$\pm(10\% \text{ rdg.} + 10 \text{ d})$ > 10 d	$\pm(5\% \text{ rdg.} + 5 \text{ d})$	2	2
U_{Probe}	Probe voltage	0 ... 253.0 V —, ~ and ~	0.1 V	—	—	—	—	—	—	$\pm(2.5\% \text{ rdg.} + 5 \text{ d})$ > 10 d	253 V	cont.	

¹⁾ The device leakage current step of the test sequence is executed by means of differential current measurement for testing per DIN VDE 0751.

²⁾ As of 25 mA: shutdown by residual current measurement within 100 ms

³⁾ Measured value P and calculated value S are compared and the smaller of the two is displayed.

⁴⁾ Measuring circuit becomes highly resistive, indication at display

⁵⁾ For DIN VDE 0701/0702: 2 k Ω , for DIN VDE 0751: 1 k Ω

⁶⁾ This measuring range with DIN VDE 0751 only

Multimeter Measurements for Devices with Feature F01

Function	Measured Quantity	Measuring Range / Nominal Range of Use	Resolution	Open-Circuit Voltage U_0	Short-Circuit Current I_K	Internal Resistance R_I	Measuring Error	Intrinsic Error	Overload Capacity	
									Value	Duration
$U_{AC/DC}$	Voltage	0 ... 253.0 V —, ~ and ≍	0.1 V	—	—	—	—	$\pm(2.5\% \text{ rdg.} + 5 \text{ d})$ > 10 d	253 V	cont.
	Low Voltage, SC III						$\pm(5\% \text{ rdg.} + 10 \text{ d})$			
R	Resistance	0 ... 150.0 k Ω	100 Ω	< 20 V–	1.1 mA	—	—	$\pm(1\% \text{ rdg.} + 3 \text{ d})$	253 V	cont.
I_{Clip}	Current with Clip-On Current-Voltage Transformer WZ12C	0.000 ... 10.00 A ~	1 mA	—	—	1.5 M Ω	—	$\pm(3\% \text{ rdg.} + 10 \text{ d})$ > 10 d without clip-on device	253 V	cont.
		0 ... 100 A ~	1 A	—	—	1.5 M Ω	—		253 V	cont.
Temp.	Temperature with Pt100/Pt1000 Sensor	- 200 ... - 50 °C	1 °C	< 20 V–	1.1 mA	—	—	$\pm(2\% \text{ rdg.} + 1 \text{ °C})$	10 V	cont.
		- 50.1 ... + 300.0 °C	0.1 °C						10 V	cont.
		+ 300 ... + 850 °C	1 °C						10 V	cont.

Reference Ranges

Line Voltage	230 V $\pm 0.2\%$
Line Frequency	50 Hz $\pm 0.1\%$
Waveshape	Sine (deviation between effective and rectified value < 0.5%)
Ambient Temperature	+23 °C ± 2 K
Relative Humidity	40 ... 60%
Load Resistance	Linear

Nominal Ranges of Use

Line Voltage	207 V ... 253 V
Line Frequency	50 Hz
Line Voltage	
Waveshape	Sine
Temperature	0 °C ... + 50 °C

Ambient Conditions

Storage Temperature	- 20 °C ... + 60 °C
Operating Temperature	- 10 °C ... + 50 °C
Accuracy Range	0 °C ... + 50 °C
Relative Humidity	Max. 75%, no condensation allowed
Elevation	Max. 2000 m
Deployment	Indoors, except within specified ambient conditions

Influencing Quantities and Influence Error

Influencing Quantity / Sphere of Influence	Designation per DIN VDE 0404	Influence Error $\pm \dots$ % of Measured Value
Position Change	E1	—
Change in Test Setup Supply Power	E2	2.5
Temperature Fluctuation	E3	Specified influence error applies per 10 K change in temperature:
0 ... 21 °C and 25 ... 40 °C		1 in case of PE measurement 0.5 for all other measuring ranges
Current at Device Under Test	E4	2.5
Low-Frequency Magnetic Fields	E5	2.5
Impedance at Device Under Test	E6	2.5
Capacitance, Insulation Measurement	E7	2.5
Waveshape of Measured Current	E8	
49 ... 51 Hz		2 for capacitive load (for equivalent leakage current)
45 ... 100 Hz		1 (for contact current) 2.5 for all other measuring ranges

Power Supply

Line Voltage	207 V ... 253 V
Line Frequency	50/60 Hz
Power Consumption	Approx. 30 VA
for function test	Continuous max. 3600 VA, power is conducted through the instrument only, switching capacity ≤ 16 A

Electrical Safety

Safety Class	I per IEC 61010-1/EN 61010-1/VDE 0411-1
Nominal Voltage	230 V
Test Voltage	3.7 kV 50 Hz
Measuring Category	II
Fouling Factor	2
Safety Shutdown	Where differential current at the DUT > 25 mA Shutdown time: < 100 ms Probe current: > 10 mA, < 1 ms

Electromagnetic Compatibility

Generic Standard	DIN EN 61326:2002
------------------	-------------------

Interference Emission		Class
EN 55022		B
Interference Immunity	Test value	Feature
EN 61000-4-2	Contact/atmos. - 4 kV/8 kV	A
EN 61000-4-3	10 V/m	C
EN 61000-4-4	Mains connection - 2 kV	B
EN 61000-4-5	Mains connection - 1 kV	A
EN 61000-4-6	Mains connection - 3 V	A
EN 61000-4-11	0.5 period / 100%	A

Mechanical Design

Display	Multiple dot matrix display, 128 x 128 pixels
Dimensions	LxWxH: 292 mm x 138 mm x 243 mm
Weight	Standard instrument: approx. 4.0 kg
Protection	Housing: IP 40 Terminals: IP 20 per DIN VDE 0470 part 1 / EN 60529

Extract from table on the significance of IP codes

IP XY (1 st digit X)	Protection against foreign object entry	IP XY (2 nd digit Y)	Protection against the penetration of water
0	not protected	0	not protected
1	≥ 50.0 mm dia.	1	vertically falling drops
2	≥ 12.5 mm dia.	2	vertically falling drops with enclosure tilted 15°
3	≥ 2.5 mm dia.	3	spraying water
4	≥ 1.0 mm dia.	4	splashing water

RS 232 Interface

Type	RS 232C, serial, per DIN 19241
Configuration	9600, N, 8, 1
Connection	9-pin subminiature socket connector

17 RS 232 Interface

The RS 232 port is used to connect the SECUTEST®PSI module (accessory), which can be installed to the lid of the SECUTEST®SII, to a PC or a barcode scanner.

17.1 Transmission of Measurement Results to the SECUTEST®PSI

Test results – except for results from individual measurements (selector switch in MENU position) and the function test – can be transmitted from the SECUTEST®SII to the SECUTEST®PSI module, where they can be stored and printed out in the form of measuring, test and statistical reports at any time.

17.2 PC Connection

Connection to an IBM compatible PC is also possible. The PC is connected to the interface at the test instrument, or to the interface port at a previously installed SECUTEST®PSI module.

17.2.1 Software Evaluation of Measurement Results

Convenient software programs such as PC.doc-WORD, ACCESS or PS3 allow for easy generation of measuring and test reports, as well as archiving of measured data.

17.2.2 Instrument Control via Interface Commands

All key functions included with the SECUTEST®SII can be simulated with the help of interface protocols, and the following parameters can be queried:

- Type of measurement and measuring range
- Test setup
- Measurement sequence progress
- Detailed measurement results

17.3 Interface Configuration and Protocol

The interface included with the SECUTEST®SII is in compliance with the RS 232 standard.

Technical Data:

Baud Rate	9600 baud, permanently set
Character Length	8 bits
Parity	none
Stop Bits	1
Data Protocol	per DIN 19244, X_ON / X_OFF protocol

Connector Pin Assignments for 9-Pin Subminiature Socket Connector:

- 1: External in + (for internal use only)
- 2: TXD (transmitter output)
- 3: RXD (receiver input)
- 4: External in +
- 5: GROUND
- 6: +5 V (500 mA output, for barcode scanner only)
- 7: Ext. in –
- 8: Control output
- 9: +9 V (1.5 A output, for PSI module only)

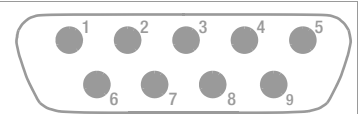

18 Appendix

18.1 Evaluation of Measured Values for Individual Measurements as well as for Calculated Quantities

In order to assure that the limit values for the individual measurements are always observed, device measuring error must be taken into consideration.

The table in the appendix allows for calculation of the required minimum display value for each respective measurement which must appear at the instrument in consideration of measuring error (under nominal conditions of use), in order to assure that the required limit value is not fallen short of (DIN VDE 0413, part 1). Intermediate values can be interpolated.

Measuring Error for Test Sequences

The test instrument takes respective measuring error into consideration during automatic test sequences, and corrected results are entered into the test report, as long as this function has been activated in the setup switch position under "include service error".

Tables for the calculation of minimum display values for insulation resistance and maximum display values for protective conductor resistance, equivalent leakage current, probe current and residual current in consideration of device measuring error:

$R_{ISO} M\Omega$		$R_{PE} \Omega$	
Limit Value	Minimum Display Value	Limit Value	Maximum Display Value
0.100	0.115	0.100	0.085
0.250	0.273	0.200	0.180
0.500	0.535	0.300	0.275
1.000	1.060	0.400	0.370
2.000	2.200	0.500	0.465
5.000	5.350	0.600	0.560
7.000	7.450	0.700	0.655
10.00	10.60 or 12.5 ¹⁾	0.800	0.750
20.00	23.00	0.900	0.845
75.00	83.50	1.000	0.940
		1.100	1.035

¹⁾ Depending upon resolution

$I_{EL} mA$		$I_{probe} mA$		$I_{RI} mA$	
Limit Value	Maximum Display Value	Limit Value	Maximum Display Value	Limit Value	Maximum Display Value
1.00	0.85	0.100	0.085	0.25	0.12
3.50	3.23	0.250	0.227	0.50	0.35
7.00	6.55	0.500	0.465	1.00	0.80
10.00	9.40	1.000	0.940	2.00	1.70
15.00	14.15	2.000	1.890	3.50	3.05
20.00	18.90	3.500	3.315	5.00	4.40
				7.00	6.20
				10.00	8.90
				15.00	13.40
				20.00	17.90
				25.00	22.40

18.2 Index

A		
Absence of Voltage	6, 7	
Acoustic Signal, Measurement	15	
Acoustic Signal, Sequence	15	
Adapter for Socket	27	
Alternating / Direct Voltage UAC/DC	22	
Auto Class PSI	15	
Auto Point	15	
Auto Test Method	27	
Auto-Store	27	
C		
Classification	12, 27	
Configuring Device Parameters	11, 15	
Configuring Measurement Parameters	11	
Connecting the Device Under Test	14	
Contact Current	6, 7, 14, 19	
Contrast Adjustment	11	
D		
DBmed Option	38	
Device Leakage Current	6, 7, 19	
Differential Current Method	7	
Direct Printing	15	
E		
Earth Fault	15	
Equivalent Device Leakage Current	6, 7, 20, 21	
Equivalent Leakage Current	6, 7, 21	
Extension Cables	34	
F		
Features	7	
Finger Contact	10	
First Measured Values	28	
Frequency Response	19	
Function Test	24	
I		
Illumination	15	
Incl. Service Error	15	
Individual Measurements	16	
Insulation Resistance	6, 17	
Insulation Resistance Limit Values	18	
Interface	43	
IT Network	15	
L		
Limit Values	15	
M		
Mains Connection Errors	10	
Mains Power Outlet	9	
Mains Wait	15	
Manual Sequence	27	
Measurements with Accessories	22	
Measuring Error	44	
Modem	15	
O		
Online Help	10	
P		
Patient Leakage Current	6	
Periodic Testing	6	
Polarity Reversal	27	
Printer Adapter	39	
Probe Voltage Uprobe	21	
Protective Conductor Resistance	6	
R		
Reference Voltage	15, 36	
Reports	15	
Residual Current	6, 19	
Residual Current Method	7	
Resistance R	22	
R-ISO LN-PE	27	
S		
Safety Class I Devices	12	
Safety Class II Devices	12	
Safety Class III Devices	12	
Saving Settings to Memory	11	
SC III UV	27	
Service	15	
Setting Date and Time	15	
Setting Limit Values	11	
Short-Circuit Test	25	
Single Fault	15	
SK5 Option	38	
T		
Test Current	6	
Test Sequence	15	
Test Time	15	
Testing after Repairs	6	
Type B Application Parts	12	
Type BF Application Parts	12	
Type CF Application Parts	12	
V		
Visual Inspection	27	
Z		
Zero Balancing	17, 23	

19 Maintenance - Calibration

Housing Maintenance

No special maintenance is required for the housing. Keep outside surfaces clean. Use a slightly dampened cloth for cleaning. Avoid the use of cleansers, abrasives or solvents.

Calibration

According to the new DIN VDE 0702:2004-06 standard the following applies as from 1/6/2004:

„Measuring instruments used for periodic testing must be inspected and calibrated at regular intervals.“

Please contact us to fix an appointment for the inspection and calibration of your test instruments: GOSSEN METRAWATT Calibration Center, Phone 0911-8602-256, address see below.

Device Return and Environmentally Compatible Disposal

The instrument is a category 9 product (monitoring and control instrument) in accordance with ElektroG (*German Electrical and Electronic Device Law*). This device is not subject to the RoHS directive.

We identify our electrical and electronic devices (as of August 2005) in accordance with WEEE 2002/96/EG and ElektroG with the symbol shown to the right per DIN EN 50419 .

These devices may not be disposed with the trash. Please contact our service department regarding the return of old devices.



20 Repair and Replacement Parts Service DKD Calibration Laboratory* and Rental Instrument Service

If required please contact:

GOSSEN METRAWATT GMBH

Service Center

Thomas-Mann-Str. 20

90471 Nürnberg, Germany

Phone: +49-(0)-911-8602-0

Fax: +49-(0)-911-8602-253

E-mail: service@gossenmetrawatt.com

This address is only valid in Germany.

Please contact our representatives or subsidiaries for service in other countries.

* **DKD** Calibration Lab for Measured Electrical Quantities: DKD – K – 19701 Accredited per DIN EN ISO/IEC 17025

Accredited quantities: direct voltage, direct current value, direct current resistance, alternating voltage, alternating current value, AC active power, AC apparent power, DC power, capacitance, frequency

Competent Partner

GOSSEN METRAWATT GMBH is certified in accordance with DIN EN ISO 9001:2000.

Our DKD calibration lab is accredited by the Physikalisch-Technischen Bundesanstalt (German Federal Institute of Physics and Metrology) and the Deutscher Kalibrierdienst (German Calibration Service) in accordance with DIN EN ISO/IEC 17025 under registration number DKD-K-19701.

We offer a complete range of expertise in the field of metrology: from **test reports** and **factory calibration certificates**, right on up to **DKD calibration certificates**. Our spectrum of offerings is rounded out with free **test equipment management**.

Our service department includes an **on-site DKD calibration bench**. If errors are discovered during calibration, our specialized personnel are capable of completing repairs using original replacement parts. As a full service calibration lab, we can calibrate instruments from other manufacturers as well.

21 Product Support

If required please contact:

GOSSEN METRAWATT GMBH **Product Support Hotline**

Phone: +49-(0)-911-8602-112

Fax: +49-(0)-911-8602-709

E-mail support@gossenmetrawatt.com

Edited in Germany • Subject to change without notice • PDF version available from the Internet

GOSSEN METRAWATT GMBH
Thomas-Mann-Str. 16-20
90471 Nürnberg • Germany

Phone: +49-(0)-911-8602-0
Fax: +49-(0)-911-8602-669
E-mail: info@gossenmetrawatt.com
www.gossenmetrawatt.com

